



Thecus VisoGuard 4.3 User Manual



Thecus VisoGuard 4.3 User Manual

Document version V3 (Release 4.3.2)

Published in September 2011

The software described in this manual is licensed under the terms of the Thecus end user license agreement and may only be used in accordance with these terms.

Copyright

Copyright © 2003-2011 NETAVIS Software GmbH. All rights reserved.

Thecus and VisoGuard are trademarks of Thecus Technology Corporation. All other trademarks are trademarks of their respective holders.

Thecus Technology Corporation
15F., No.79, Sec. 1, Sintai 5th Rd., Sijhih City
Taipei County, Taiwan R.O.C.

Tel +886 (2) 2698 1788

Fax +886 (2) 2698 9098

info@thecus.com

www.thecus.com

Contents

1 Introduction.....	5
1.1 The VisoGuard documentation set	5
1.2 What is new with this release	5
1.3 VisoGuard data security	5
1.4 Video streaming methods and compression	6
2 Starting and operating the VisoGuard client.....	10
2.1 Introduction to the VisoGuard client.....	10
2.2 Starting the VisoGuard client from a standard web browser	11
2.3 Working with the installed VisoGuard client	14
2.4 Client multi-window and multi-screen operation	17
2.5 VisoGuard Transcoding™ for low-bandwidth client-server connections (ABS)	19
2.6 Exiting the client.....	20
3 Setting up cameras	21
3.1 Preparations.....	21
3.2 Adding a new camera and setting basic properties	21
3.3 Setting up the camera recording archive	27
3.4 Optional: Configuring video analytics (iCAT)	27
3.5 Defining brightness, contrast, and saturation	27
3.6 Working with camera groups	28
3.7 Changing the port mapping of analog cameras.....	29
4 Managing users	30
4.1 Creating a new user account	30
4.2 Setting general user privileges	31
4.3 Setting camera access rights.....	32
4.4 Working with user groups	32
4.5 Defining Online Monitor views for a new user	32
4.6 Information about logged-in users	33
4.7 Changing the password	33
4.8 Working with users from Active Directory or LDAP	33
5 Using the Online monitor.....	35
5.1 Creating a new view.....	35
5.2 Selecting cameras	36
5.3 Navigating in the Online monitor.....	37
5.4 Modifying view port settings.....	38
5.5 Zooming in a view port and in archive recordings	39
5.6 Manual recording control in the Online Monitor	40
5.7 Working with round tours (the Smart guard™ function)	41
5.8 Copying views between users	42
5.9 Working with MPEG cameras and audio (MPEG-4, H.264, and MxPEG)	42
5.10 Dynamic Online monitor view control	43
6 Working with archive recordings.....	45
6.1 Programming archive recordings.....	45
6.2 Playback of archive recordings.....	48
6.3 Exporting recordings (images and video sequences).....	54
6.4 Motion detection in archive recordings	56
7 Working with simple motion detection	58
7.1 VisoGuard's own server-based motion detection	58

7.2 Motion detection in archive recordings	61
7.3 In-camera motion detection	61
8 Handling events	63
8.1 Event list and event details	63
8.2 Searching in the event database	65
8.3 Generating an event statistics report	67
9 Working with PTZ cameras	69
9.1 Setting up a PTZ camera	69
9.2 Defining fixed PTZ positions	69
9.3 Defining PTZ routes	69
9.4 Controlling PTZ cameras	70
10 Administrating VisoGuard servers	75
10.1 Server system information and restarting	75
10.2 Setting VisoGuard server parameters	78
11 Working with interconnected VisoGuard servers	82
11.1 Basic concepts of interconnected VisoGuard servers	82
11.2 Adding and defining a remote VisoGuard server	83
11.3 Working with cameras of another server	84
11.4 Working with events of remote servers	86
11.5 Monitoring remote servers	86
12 VisoGuard on mobile devices	87
12.1 Supported devices	87
12.2 Installing the VisoGuard client on a mobile device	87
12.3 Running the VisoGuard client on a mobile device	87
13 Working with Layout Navigation	88
13.1 Basic concepts and how it works	88
13.2 Installing the layout navigation tool	88
13.3 Starting the layout navigation tool	89
13.4 Setting up a project and defining layouts (Editing mode)	89
13.5 Customizing the behavior and appearance of controls	92
13.6 Layout navigation and operation (Navigation mode)	97
14 Video analytics with iCAT	100
14.1 iCAT highlights	100
14.2 Basic iCAT concepts	101
14.3 Setting up a camera for video analytics with iCAT	103
14.4 Working with iCAT	117
15 Special functions	122
15.1 Video annotations	122
15.2 Embedding VisoGuard video streams in web pages (Snapplet)	122
15.3 Controlling VisoGuard with HTTP commands from external sources (URL control)	123
15.4 Matrix view function of the Online monitor (VIP control)	124
15.5 Holiday calendar	125
15.6 Automatic export of event statistics data	126
15.7 Configuring I/O devices	127
16 Index	129

1 Introduction

Thank you for choosing Thecus VisoGuard 4.3 as the management software for your video monitoring system. As you use it, you will find that VisoGuard not only enables you to view live images and record them, but also provides a full-scale platform for the intelligent utilization of your video data.

This User Manual guides you through the functionality of Thecus VisoGuard 4.3.

If you have questions that are not answered in the VisoGuard documentation set, please contact your Thecus distribution partner, or our product management team directly by e-mail or telephone +886 (2) 2698 1788.

We wish you an interesting and productive experience with Thecus VisoGuard 4.3.

Your Thecus Team.

1.1 The VisoGuard documentation set

These documents are available:

- *Thecus VisoGuard User Manual*
- *Thecus VisoGuard Supported Video Sources*

These documents are available online as PDFs directly on each VisoGuard server via the standard web interface and also from each client via the **Info** menu at the lower right corner.

1.2 What is new with this release

The changes of a release are documented in the **Release Notes**, which you can find on the standard web interface of each VisoGuard server and also under the following direct link:

<http://<your-server>:8080/relnotes>

or on the public demo server

showroom.netavis.net/relnotes

There you also find the release information of previous releases.

1.3 VisoGuard data security

VisoGuard has been designed to provide the highest level of robustness and data security. The following aspects of the VisoGuard system document that:

- All video and configuration data on an VisoGuard server are stored in separate file system partitions, protected by multiple levels of security.
- Optionally the video data can be stored using 128 bit AES encryption (new since release 4.0)
- Optionally HTTPS can be used for streaming video data between cameras and servers (new since release 4.0).
- Optionally HTTPS can be used for streaming video data between server and clients (new since release 4.2).
- In any case, the authentication data (user names and passwords) transferred between clients and servers are encrypted by MD5 strong encryption.

Please note: Encryption and decryption can mean higher CPU overhead at the server and/or the client. Also doing something with the contents of an encrypted stream means decryption and therefore higher CPU overhead. For example, doing video analytics with an encrypted video stream means that it has to be decrypted at the server before processing. Likewise, storing an unencrypted stream in an encrypted video database means that it has to be encrypted at the server before storing. Likewise, displaying an encrypted video stream at the client means more CPU overhead at the client because it has to be decrypted.

On the other hand, simply storing an already encrypted video stream coming from the camera does not need more CPU at the server than storing an unencrypted video stream.

1.4 Video streaming methods and compression

VisoGuard supports video streaming in several standards:

- Motion JPEG (often also referred to as MJPEG)
- MPEG-4 streaming
- H.264 streaming (also known as MPEG-4/AVC)
- MxPEG streaming (this is a streaming standard specially developed by www.mobotix.com for their IP cameras)

The big difference between the various streaming methods is the way how the image data are compressed and transferred. The selected streaming method has great influence on:

- the **bandwidth** needed for transmission between cameras and server but also between servers and clients,
- the **CPU load** at the server and the client induced by compression and decompression, and
- the **storage requirements** for recording

For low-bandwidth client-server connections VisoGuard offers the unique Transcoding™ feature (see *2.5 VisoGuard Transcoding™ for low-bandwidth client-server connections (ABS)* on page 19).

1.4.1 Multi streaming (multiple parallel video streams from the camera)

Some cameras are capable of providing multiple parallel video streams to VisoGuard. This can be helpful, for example, when online viewing and recording is to be done in different formats (e.g. different sizes and frame rates) or for optimizing iCAT video analytics performance (see *14.2.1 Considerations for setting up a system with iCAT* on page 101).

Usually MJPEG cameras can deliver several MJPEG streams while MPEG cameras (MPEG-4, H.264, and MxPEG) usually can deliver only 1 or 2 MPEG streams and some camera types can deliver several MJPEG streams in addition to the MPEG stream(s).

However there are a few important restrictions with multi streaming:

- Some cameras have performance limitations in providing multiple streams depending on the streaming format, resolution, and frame rate. We found out that some cameras just stop streaming when the streaming processors of the camera get overloaded by certain resolution and frame rates settings. Please refer to the camera data sheet and documentation.
- In the current version VisoGuard supports 1 format setting for MPEG streams (MPEG-4, H.264, and MxPEG) and multiple format settings for MJPEG streams.

Please note: Please refer to camera data sheet and documentation for camera limitations. Also the document *Thecus VisoGuard 4.3 Supported Video Sources* may provide further details on camera restrictions.

1.4.2 Motion JPEG

A network camera captures individual images and compresses them into a JPEG format. The network camera can capture and compress, for example, 30 such individual images per second (30 fps), and then make them available as a continuous flow of images over a network to an VisoGuard server which then distributes it to VisoGuard clients and / or stores it in the camera archive. At a frame rate of about 16 fps and above, the viewer will perceive full motion video.

As each individual image is a complete JPEG compressed image, they will all have the same guaranteed quality, determined by the compression level as defined for the network camera or network video server.

Example of a sequence of three complete JPEG images:

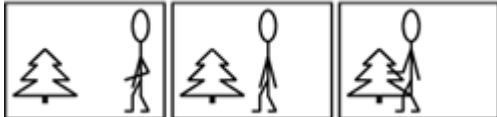

1.4.3 MPEG (MPEG-4, H.264, and MxPEG)

Some of the best-known audio and video streaming techniques are defined by the so called MPEG consortium (Moving Pictures Expert Group). Under the MPEG umbrella several streaming methods are available like MPEG-4, H.264, and MxPEG (strictly taken, MxPEG is not part of the standards defined by the MPEG group but is a proprietary standard by the company Mobotix. However, because of reasons of simplicity we refer to MxPEG also as an MPEG format). MPEG-4 and H.264 are well known and widely supported MPEG streaming standards.

Simply described, MPEG's basic principle is to compare two compressed images to be transmitted over the network, and using the first compressed image as a reference image (called an I-frame), only sending the parts of following images (B- and P-frames) that differ from the reference image. A viewing client will then reconstruct all images based on the reference image and the "difference data".

At the cost of higher complexity, the result of applying MPEG video compression is that the amount of data transmitted across the network is less than that of Motion JPEG. This is illustrated below where only information about the differences in the second and third frames is transmitted



H.264 and MxPEG all work very similar to MPEG-4 whereby H.264, for example, needs only about 60% of the bandwidth of MPEG-4 for roughly the same video quality. However, this efficiency does not come for free. Encoding and decoding H.264 needs more CPU power than MPEG-4. A general rule is that the higher the compression factor the heavier the CPU burden (in the server and in the clients). Therefore there is always a tradeoff between bandwidth utilization and CPU power needed.

1.4.4 Advantages and disadvantages of Motion JPEG and MPEG (MPEG-4, H.264, and MxPEG)

Due to its simplicity, Motion JPEG (MJPEG) is a good choice for use in many applications. JPEG is a widely available standard in many systems often by default. It's a simple compression/decompression technique, which means the cost, in both system time and money, for encoding and decoding is kept low. The time aspect means that there is limited delay between image capturing in a camera, encoding, transfer over the network, decoding, and finally display at the viewing station. In other words, MJPEG provides low latency due to its simplicity (image compression and complete individual images), and for this reason it's also well suited for when image processing is to be performed, for example video motion detection or object tracking.

MJPEG gives a guaranteed image quality regardless of movement or complexity of the image scenes. It still offers the flexibility to select either high image quality (low compression) or lower image quality (high compression) with the benefit of lower image file sizes, thus lower bit-rate and bandwidth usage. At the same time the frame rate can be easily controlled, providing a means to limit bandwidth usage by reducing the frame rate, but still with a guaranteed image quality.

Since MJPEG does not make use of a video compression technique, it generates a relatively large amount of image data that is sent across the network. For this reason, at a given image compression level (defining the image quality of the I-frame and JPEG image respectively), the network bandwidth is less for MPEG compared to MJPEG, except at very low frame rates.

Another difference is that most MJPEG IP cameras can produce multiple simultaneous streams and in different qualities (image sizes and compression quality) while most MPEG cameras can produce only one stream in one quality. Therefore the same stream will be used in live viewing and recording.

This summarizes the benefit of MPEG: the ability to give a relatively high image quality at a lower bit-rate (bandwidth usage). This can be especially important if the available network bandwidth is limited, or if video is to be stored (recorded) at a high frame rate and there are storage space restraints. The lower bandwidth demands come at the cost of higher complexity in encoding and decoding, which in turn contributes to a higher latency when compared to MJPEG.

The graph below shows in principle how bandwidth use between MJPEG and MPEG compares at a given image scene with motion. As can be seen, at very low frame rates, where MPEG compression cannot make use of similarities between neighboring frames to a high degree, and due to the overhead generated by the MPEG streaming format, the bandwidth consumption is actually higher than MJPEG.

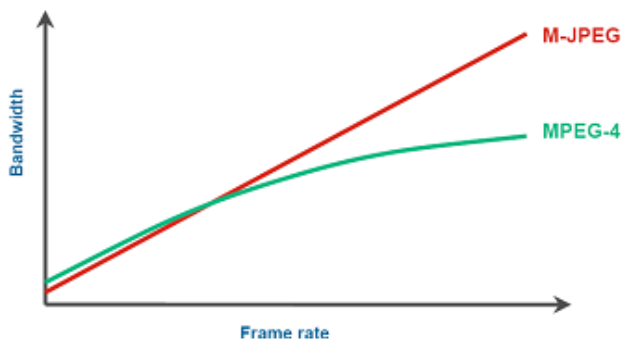

1.4.5 JPEG image sizes and storage requirements

The image (recording) quality and image size affects the required storage per image (frame). Likewise does the frame rate impact the recording storage and also the network bandwidth.

VisoGuard supports all image sizes that a camera offers. The following are some **values for typical JPEG images**:

JPEG Image size	Image quality	Storage per image approximately
Small 176x144 QCIF PAL 176x120 QCIF NTSC 160x120 QQVGA	Low	3 KB
	Medium	5 KB
	High	8 KB
Medium	Low	8 KB

JPEG Image size	Image quality	Storage per image approximately
352x288 CIF PAL 352x240 CIF NTSC 320x240 QVGA	Medium	13 KB
	High	20 KB
Large* 704x576 4CIF PAL 704x480 4CIF NTSC 640x480 VGA	Low	20 KB
	Medium	34 KB
	High	52 KB

* For mega-pixel cameras the image size will be much bigger than shown in the table.

2 Starting and operating the VisoGuard client

2.1 Introduction to the VisoGuard client

Once you have successfully installed VisoGuard on your server, authorized users can access the server via an VisoGuard client.

Normally the VisoGuard client runs on a PC separate from the server, however in a client-on-server installation the client runs directly on the server (see the document *Thecus VisoGuard 4.3 Server Installation and Administration* for further information on how to create and run a client-on-server installation).

Licensing issues

The available functionality of your VisoGuard installation is defined by the license string. The document *Thecus VisoGuard 4.3 Server Installation and Administration* describes how licensing works and how to obtain a license string. If you have a temporary demo license, a **License** dialog appears at every login indicating that there is no permanent license. At this dialog just push the **Continue** button to operate VisoGuard in the demo mode.

See *10.1 Server system information and restarting* on page 75 for how to display the current license of your server.

Different clients

You can choose among these VisoGuard clients, operating systems and platforms:

VisoGuard client	OS and platform	Supported functionality
Locally installed client	MS Windows 7, XP, Vista, etc.	All
	Linux, Unix (also client on server)	No audio, layout navigation, and PTZ-Joysticks; Mac OS-X: additionally no MPEG streaming (MPEG-4, H.264, and MxPEG)
Standard web browser	MS Windows 7, XP, Vista, etc.	No layout navigation and Joysticks for PTZ control
	Linux, Unix	No audio, layout navigation, and PTZ-Joysticks; Mac OS-X: additionally no MPEG streaming (MPEG-4, H.264, and MxPEG)
Mobile client	Apple iPhone and iPad	Online viewing only

Please be aware that some functions like Layout Navigation and running SAFE export files may only be available on the MS Windows platform.

This chapter describes how to start the VisoGuard client on a desktop PC. If you want to run VisoGuard on a mobile device please refer to *12 VisoGuard on mobile devices* on page 87.

The minimum screen resolution for running the VisoGuard client is 1024x768 pixels.

2.1.1 Advanced client technology

The VisoGuard uses advanced technologies to ease the operation of clients on MS Windows platforms:

- **Lazy-loading client technology:** VisoGuard clients (both browser-based and locally installed) only load the needed application components from the server on demand, when they are needed. This saves time at startup and also bandwidth. It also eases the management and upgrading of clients. Libraries for one version are downloaded only once and are now stored locally on the client machine. The path is <user's home directory>\netavisLibs\<version> (e.g. D:\Documents and Settings\user\netavisLibs\1.9.0.110.200).
- **Automatic client upgrading:** Whenever the VisoGuard server is upgraded to a new version, the clients are automatically upgraded too. This is happening transparently to the user. The same client will still be able to work with older server versions (see next point). Starting with release 1.9 the client application has to be installed only once and every further VisoGuard version will be seamlessly accessible, without having to manually upgrade the client.
- **Different versions between servers and clients:** Starting with release 1.9 VisoGuard clients can connect to servers running different versions (release 1.9 or newer) without the need to install clients matching the servers' versions.

As a summary, VisoGuard clients...

- ...download libraries (for one version) only once
- ...share the same libraries for both browser-based (applet) and installed client application
- ...can connect to servers having different versions
- ...automatically upgrade themselves when the server has a new version

2.2 Starting the VisoGuard client from a standard web browser

This section describes how to start the client in a standard web browser. If you want to install the client on your machine and run it independently of a web browser, please refer to *2.3 Working with the installed VisoGuard client* on page 14.

Generally you can start the client with an unencrypted HTTP connection or with an encrypted HTTPS connection.

1. To access the client via an unencrypted HTTP connection start a web browser and enter the address of your VisoGuard server: `http://IP-address-of-your-server:8080`

To access the client via an encrypted HTTPS connection start a web browser and enter the address of your VisoGuard server: `https://IP-address-of-your-server:8080`

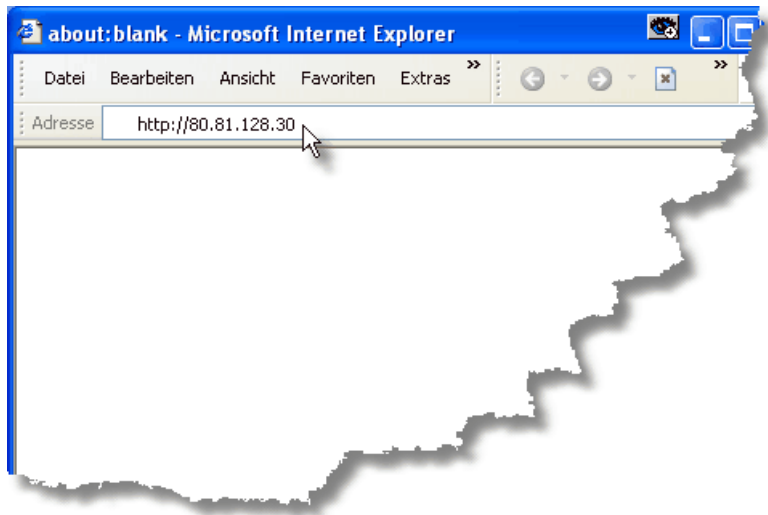

Now a page that checks the availability of the Java on your computer appears. This page should disappear in a few seconds.

If this page stays, it means that you do not have the Java plug-in installed on your browser. You have to first install Java by visiting www.java.com/download to install the latest Java 2 package and then start the browser anew. Now the screen should disappear and you can continue as shown below.

2. Next a startup screen is displayed that lets you choose the language that you want to use. Click on your language of choice and push **Start**. This takes you to the start page of VisoGuard:
3. Click on **Start VisoGuard client (from the browser using Web Start)**. Depending on the browser you are using you might be asked whether you want to execute the Java JNLP link. Click on OK (to tell the browser to automatically start see 2.2.1 *Optimizing the Web Start behavior of your browser* on page 14). Now you will be advised that the program is being loaded. How long loading takes depends on your network. On completion of loading, you will be notified that VisoGuard is initializing. Then user data is loaded.

Note: By clicking on **Install the VisoGuard client on your PC** you can also install the VisoGuard client on your machine locally (see 2.3 *Working with the installed VisoGuard client* on page 14).

4. Before starting the VisoGuard client you will be asked if you allow to execute the downloaded trusted applet:



Select the checkbox **...always trust...** and click on **Yes** to allow the download of the trusted applet.

When you start the client the first time after a new installation some additional client application components need to be installed (this is needed only once per client). You will be asked:

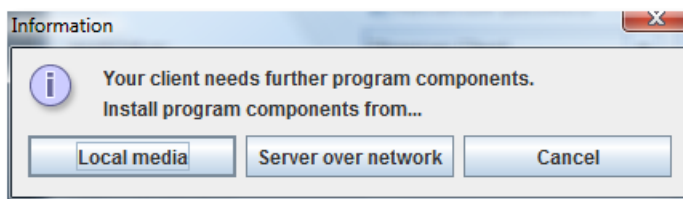

Normally you want choose to install the program components from **Server over network**. However, if you have a very slow network connection between the client and the server you might want to choose installation from **Local media**. When you choose this option you will be asked to locate the directory **ClientInstaller** of the VisoGuard installation CD. Once you choose the correct location and push OK, the components will be installed.

- Next you either come to the login panel or to the license dialog. If the license dialog appears you yet have to obtain a license for using VisoGuard. Please consult the manual *Thecus VisoGuard 4.3 Server Installation and Administration* for information on how to do that. At the login panel enter your **Login name** and **Password** and click **OK**.

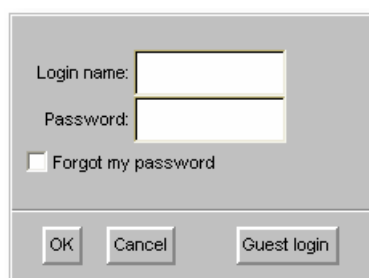

If you do not yet have a permanent license string for VisoGuard, a **License** dialog appears. To continue without a permanent license just push **Continue**. In this case the full functionality may not be available. See also 2.1 *Introduction to the VisoGuard client* on page 10 for further details about licensing.

Please note: The authentication data transferred between client and server are encrypted with MD5 strong encryption.
The administration user **admin** has the default password **admin**. For security reasons you should change this password (please see *4 Managing users* on page 30).

A guest login is possible only if the guest has been defined on your server (which is the factory setting). For further details contact your VisoGuard administrator.

If you have forgotten your password, you can mark the **Forgot my password** checkbox, answer the asked question, and click **OK**. For more information, ask your VisoGuard administrator.

2.2.1 Optimizing the Web Start behavior of your browser

When you click on a Java Web Start link (JNLP) like the **Start VisoGuard client (from the browser using Web Start)**, some browsers ask whether you want to download and save the file Web Start JNLP file instead of executing it. This can be annoying because you have to first save the file and then execute it manually. Here is how you can automate that for various web browsers.

Optimizing Web Start for Google Chrome

1. Click on the link that you are trying to launch, and Chrome will download it, as before.
2. By default Chrome will list the download on the bottom of the page. To the right of the filename is a small drop down arrow, click it.
3. From the menu that pops up select **Always open files of this type**. Now, when you click on the Web Start link the next time, the application will start automatically.

2.2.2 What is next

If your VisoGuard server already has cameras configured, then you can go to chapter *5 Using the Online monitor* on page 35. If you have to setup cameras first, then continue with chapter *3 Setting up cameras* on page 21.

Furthermore, because VisoGuard behaves in a context-sensitive way, you will find that certain menu items are also disabled at certain times. Thus, for example, you cannot remove a camera if there is no camera to remove. Thus in different contexts the same menu might look quite different at different times (menu entries and buttons in grey are disabled and in black are enabled).

2.3 Working with the installed VisoGuard client

Alternatively to starting the VisoGuard client from a web browser you can also install the Java client application locally on your machine. Some functions are only available in the installed client (see *2.1 Introduction to the VisoGuard client* on page 10 for details).

2.3.1 Installing the VisoGuard client

To **install** the client locally on your PC, please follow these steps:

1. At the **VisoGuard Start page** click on the link **Install the VisoGuard client on your PC (using Web Start)**.
2. Save and run the Web Start installer.
3. Follow the steps of the setup program.

Alternatively you can also download and run the client installer executable on Windows platforms:

1. At the **VisoGuard Start page** click on the link **Alternative installation: Download VisoGuard client installer executable (Windows only)**.
2. Save the client installer executable at an arbitrary location.

3. Execute the just downloaded client installer (Observer_setup.exe).
4. Follow the steps of the setup program (standard Windows installation).

2.3.2 Starting the installed VisoGuard client

Once the setup finished you can start the client locally from your Windows **Start** menu (or also from a desktop icon if you selected so at installation). The **Starter** window appears:

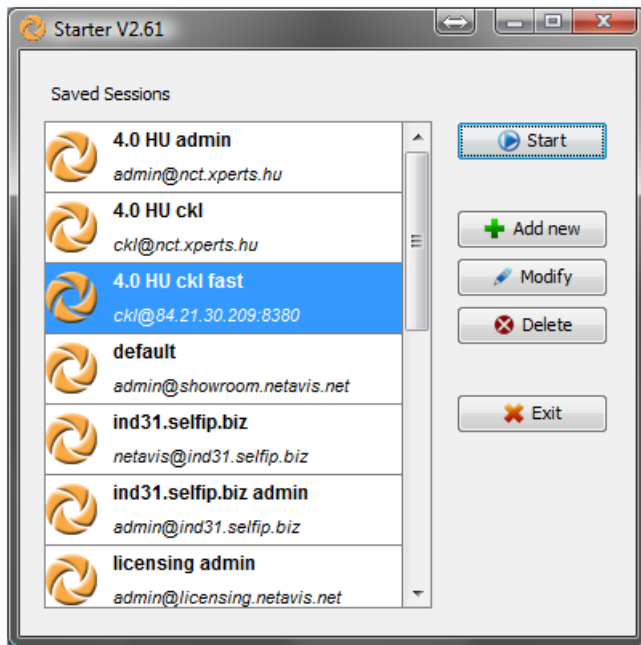

Working with sessions

The **Starter** allows you to manage sessions. In a session you can define the server address, which VisoGuard application to start and the user/password details. Thus you can store and run different sessions easily.

The **Session editor** is opened when you push **Add new** or **Modify** and allows you can define the session details:

Element	Meaning
Session name	Name under which the session is stored.
Application	You can either choose VisoGuard Client or Layout Navigation Tool (for further details on the Layout Navigation Tool please refer to <i>13 Working with Layout Navigation</i> on page 88). The selected application will start when you press OK .
Previous Sessions	Offers you the list of previously active sessions.
Hostname or IP Address	Enter the name or IP address of the server you want to connect to. Please note that you have to add Port 8080 to the address of the server. For example, the IP address would then look like 192.168.0.7:8080 or my-visoguard-server.com:8080 .
Use secure connection	Select this checkbox if you want to use an encrypted connection between the client and the server (SSL HTTPS). Please be aware that an encrypted connection needs more CPU resources on the server and on the client. See also <i>1.3 VisoGuard data security</i> on page 5.

Element	Meaning
Username	Enter the login name of the user.
Password	Enter the password for the user.
Remember password	Select the checkbox if you want the password to be remembered for the next start of the application.

Starting the VisoGuard client

Pushing **Start** in the **Starter** will open the client window and connect you to the VisoGuard server. When the client is started, the **Starter** window will be hidden and in the task bar you will see its icon. You can access the Starter by clicking its icon. There you can open the Starter dialog again and also force an exit of the client application.

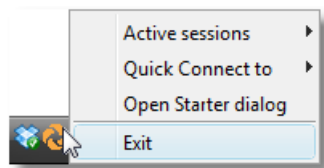

When you start the client the first time after a new installation some additional client application components need to be installed (this is needed only once per client). You will be asked:

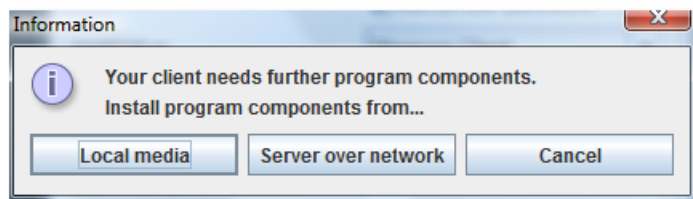

Normally you want choose to install the program components from **Server over network**. However, if you have a very slow network connection between the client and the server you might want to choose installation from **Local media**. When you choose this option you will be asked to locate the directory **ClientInstaller** of the VisoGuard installation CD. Once you choose the correct location and push OK, the components will be installed.

If you do not yet have a permanent license string for VisoGuard, a **License** dialog appears. To continue without a permanent license just push **Continue**. In this case the full functionality may not be available. See also *2.1 Introduction to the VisoGuard client* on page 10 for further details about licensing.

Using a different directory for the installed client application components

Per default, the downloaded client application components will be installed in the directory %USERPROFILE%\netavisLibs (e.g. C:\Documents and Settings\user\netavisLibs). You can redefine this directory by setting the environment variable NETAVIS_DIRECTORY. The directory must exist prior to starting the VisoGuard client. If the variable does not exist, the client components will be installed in the standard directory.

Here is how you can set an environment variable in Windows 7:

1. Right click on the Computer icon in your Explorer or on your Desktop and choose **Properties**.
2. In the System window click on **Advanced system settings** in the left pane.
3. In the **System Properties** window select **Advanced** tab and click on the button **Environment Variables** at the bottom of the dialog.
4. In the **Environment Variables** window you will notice two tables **User variables** for the current user and **System variables** for all users.

5. To add a new **User variable** click on **New...** button. In the **New User Variable** dialog box enter the variable name `NETAVIS_DIRECTORY` and the location of the directory and then click **OK**. The default location would be `%USERPROFILE%\netavisLibs`.
6. Click OK in the Environment Variables dialog window and close the other dialogs as well.

Working with sessions of pre-4.0 servers

The **Starter** also allows you to also manage sessions with VisoGuard servers running releases older than 4.0. Just select the checkbox **Show settings for pre-4.0 releases** to show the additional settings.

Description of elements:

Element	Meaning
Window width, height	Define the size of the client window in pixels.
Upper left corner X, Y	Define the location of the upper left corner of the client window in pixels. This setting can be changed, e.g., for multi-screen setups.
Initial monitor view name	Is optional and defines the initial Online monitor view.
Window decoration visible	Defines whether the windows decoration border is visible.
Tool control bar visible	Defines whether the tool control bar at the right side of the window is visible. This bar allows switching between Online Monitor, Archive Player, Event Management and Administration.
Event bar visible	Defines whether the event bar at the bottom of the window is visible.
Online monitor control bar visible	Defines whether the  menu and the history buttons for Online monitor control are visible.
Overlay painting enabled	When this is selected and the hardware supports it the Online monitor uses the hardware overlay technique for displaying flicker-free MPEG streams. This can also boost the client performance and relieve the main CPU. In multi-screen operation, overlay painting of MPEG video streams may result in pink colored view ports if the client is not running on the primary screen of Windows. Then you should turn off this feature.

2.4 Client multi-window and multi-screen operation

VisoGuard supports multi-window and multi-screen operation. With clients that have multiple screens connected you can position windows at different screens.

Here is an example of a client setup with 3 screens:



The window contents and positions are automatically stored per user and between sessions. This means when a user has multiple windows positioned on 3 screens and he exits and then logs in again, all the windows on the 3 screens will automatically be restored.

Please note: There can only be one Archive player and this is located in the main window.

2.4.1 Creating a new window

In the main application window select **New window** from the **Windows** menu.

The window title and the contents of the window can be adapted by choosing **Client preferences...** in the VisoGuard menu (see below).

2.4.2 Defining what components to display in a window

For each window you can define which of these components should be displayed in the window:

- Online Monitor
- Archive player
- Event list
- Camera tree

You can define any combination of components and you can also define that a window should contain only one component.

Note: Depending on the authorization that your VisoGuard administrator has assigned to you, some of the client components could be disabled (menu shown in grey color). If you need more authorization, please contact your local VisoGuard administrator.

Here is how you can define what components are to be shown in a window:

1. In the VisoGuard menu choose **Client preferences...** which will open the dialog.
2. For each window you can define what should be displayed. For example, select the **Online monitor** node and turn on (select) the **Display Online monitor** check box. For each window individually you can turn on or off the **Event list**, **Camera tree**, and **Archive player** (only for the main window).

Please note: Normally it does not make sense to always show the camera tree since it will be opened when needed on demand.

2.4.3 Modifying window layouts

You can also modify the layout of a window by rearranging its components. Once you have defined in the **Client preferences** dialog what components are to be shown in a window you can customize the layout. Select the menu **Windows->Enable layout customization**. For the Event list and the Camera tree you can now define:

- Where they are located inside the window: Just click on the title bar of the Event list or the Camera tree and drag it to a different location. For example, when the Online monitor and the Event list are enabled, then you can drag the Event list from the default position at the right border of the window to the bottom of the window.

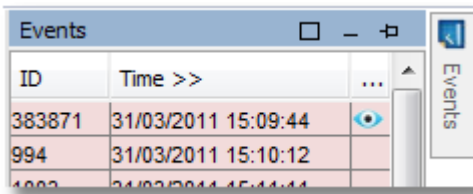

- Whether they are floating (open when needed or there are new entries and collapsed or hidden otherwise) or pinned (always shown): You can change the state of the Event list or the Camera tree by pinning or unpinning it in the title bar.

Whether the Event list or the Camera tree should fill the whole window: You can maximize the component by pushing the maximize button . When a component is maximized, it will occupy the whole space of the window and will automatically resize when you resize the window. Thus you can create a window that contains only an Event list.

After you are done with the modifications deselect **Windows->Enable layout customization**.

The default location for the Event list is the right window border and for the Camera tree (that usually only pops up when needed) it is the left window border.

Please note that only the Event list and the Camera tree can be dragged. The other components in the window will then change their size accordingly.

2.4.4 Deleting a window

In the main application window select **Delete window...** from the **Windows** menu. A **Delete window** dialog will open, offering you the list of available windows for deletion.

2.4.5 Positioning a window on a certain screen

Positioning a window on a certain screen is very easy: With the mouse just drag the window to the screen and drop it there. You can also maximize the window on the screen. All the window states will be remembered between sessions. This happens on a per-user basis, which means when the user is logging in on a different client workstation he will have the same window setup as on the first client workstation.

2.5 VisoGuard Transcoding™ for low-bandwidth client-server connections (ABS)

The unique VisoGuard Transcoding™ technology (also called ABS for active balanced streaming) reduces the necessary bandwidth for video streams to a fraction of the usual values. Especially high-resolution cameras can thus be streamed from server to clients over low-bandwidth wide areas network (WAN) connections without loss of quality. Therefore even megapixel cameras can be operated over very low bandwidth connections that would normally prevent their operation. The technology works for all cameras, streaming resolutions, and formats (including MPEG-4, H.264, and MxPEG).

Additional CPU resources are needed at the server and at the client for transcoding streams.

Transcoding™ can be set up in the server level by limiting bandwidth for live video and recording playback streams as well as for recording exports (defined in *10.2 Setting VisoGuard server parameters* on page 78).

Important: Although transcoding works with all streaming formats, the **best results and least CPU overhead** are possible with MJPEG streaming. Also the transcoding bandwidth limit must be chosen carefully.

Therefore **we suggest:**

- **MJPEG streaming format.**
- **Limit the transcoding bandwidth to app. 70% of the available server-client connection bandwidth.**

For connections, like Internet connections, with heavily varying bandwidth it is much better to use a lower limit than a higher limit. With low limits of 256 kbit/s or 128 kbit/s very good results are possible. Some customers have even used 56 kbit/s or 30 kbit/s with transcoding.

As indicated above the limits are defined in *10.2 Setting VisoGuard server parameters* on page 78.

2.6 Exiting the client

The VisoGuard client can be exited by choosing **Exit** from the **VisoGuard** menu at the main application window. You will be asked whether you really want to exit.

If the menu bar is hidden, you can exit the client via the right mouse button menu.

3 Setting up cameras

VisoGuard allows any authorized user to set up cameras in the system. Ask your VisoGuard system administrator whether you have such authorization.

3.1 Preparations

Before you begin to set up a new camera in VisoGuard, be sure to have the following information available:

- Your camera type.
- Is your camera type supported by VisoGuard?
Please consult the document *Thecus VisoGuard 4.3 Supported Video Sources*.
- Are there available licenses for setting up additional cameras?
- IP addresses of cameras (or camera servers).

Please note: Here we describe how to setup a camera in VisoGuard. If you setup an IP camera, then the camera itself also can be configured. This is normally done via a web-based interface of the camera. Please consult the manual of your IP camera for further details.

3.2 Adding a new camera and setting basic properties

Start the VisoGuard client application (see 2 *Starting and operating the VisoGuard client* on page 10).

You can either

- add a new camera from scratch, or
- duplicate an existing camera and just modify some parameters (see 3.2.2 *Duplicating an existing camera* on page 27). Duplicating an existing camera creates an exact duplicate with all settings copied. This is useful when you have more than one camera of the same type or with equal/similar settings (like recording or video analytics settings).

3.2.1 Adding a camera from scratch

1. Choose **Camera admin** from the **System administration** menu. This opens the **Camera admin** dialog.
2. With a mouse click, select the camera group to which you want to add the new camera (later on you can move the camera in the camera tree to a different group).
3. Choose **Add new camera** from the menu.

The **Properties** dialog opens in which you can configure the camera.

Enter your camera data in the corresponding fields. Use the following table as a guide. Fields labeled in **bold** are **mandatory** while all others are optional:

Field label	Your input
Camera name	Enter the name that you want to give your camera. This is the name by which you will select or display this camera (e.g., camera 2).
Comment	Here you can add text that describes your camera.

Field label	Your input
Time zone	Select the time zone of your camera's location (e.g., CET for a camera installed in Vienna).
Camera type	Specify the type of camera by selecting it from the camera pop-up menu. Important: If you want to connect an analog camera via a video server then select the type of the video server from the menu. If you connect an analog camera to a video capture card directly in the VisoGuard server, then select NDS (VisoGuard Digitizer Server) as your camera type.
Name of camera admin	If the camera needs authentication for administrating, then enter the user name of the camera administrator here.
Pwd of camera admin	Enter the password of the administrator account of the camera (only if used).
Camera IP address	Specify the IP address or network name of your camera or video server. If you supply a network name, you must have access to a domain name server (DNS) that resolves the name to an IP address. Even dynamic DNS names (like dyndns) can be used. This field is not needed for analog cameras connected directly via a video capture card (NDS).
Camera server port	If you are adding an analog camera via a video capture card (NDS) or via a video server, specify the port of the capture card or video server to which the camera is connected.
Aspect ratio	This setting is only enabled for certain IP cameras that are shipped with different aspect ratios (like PAL or NTSC). For cameras that are delivered in one standard only, the correct value is set automatically and cannot be changed. Please select the correct value for your camera. If you select a value that does not fit your camera, then the image might be distorted. Please refer also to <i>1.4.5 JPEG image sizes and storage requirements</i> on page 8.
Streaming mode (Mobotix only)	This option is only relevant if you use a Mobotix camera. Set it when you would like to operate the camera in streaming mode. If this option is not activated, the camera operates in single picture mode. In streaming mode (MJPEG format) the camera delivers higher frame rates than in single picture mode. If you activate the streaming mode you also must set the according option in the camera with the Admin tools of the camera.
Use HTTPS encryption	If the camera supports encrypted streaming using HTTPS this setting will be enabled. It defines whether streaming from the camera is encrypted using HTTPS. Please note that encryption needs significantly more CPU resources on the server than unencrypted communication (see also <i>1.3 VisoGuard data security</i> on page 5).
Non-interlaced mode	This option is only relevant for digital cameras or video servers that

Field label	Your input
enabled	support 2CIF resolution to reduce the interlace effect. Please refer to the camera's documentation.

Push **Save** to create the new camera.

- Select the newly created camera again in the camera tree and then push the **Next** button at the bottom. This invokes the **Default settings** dialog that lets you define the default image and audio settings for your camera. To modify values choose **Modify selected camera or group** menu.

Fields for **Basic video and audio settings**:

Field label	Your input
Multi stream allowed	<p>Some cameras are capable of providing multiple video streams in parallel. This can be helpful for example, when online viewing and recording is to be done in different formats or for optimizing iCAT video analytics performance (see <i>1.4 Video streaming methods and compression</i> on page 6 for a general discussion about multi streaming).</p> <p>Usually MJPEG cameras can deliver several MJPEG streams while MPEG (MPEG-4, H.264, and MxPEG) cameras deliver only 1 MPEG stream (some camera types can deliver several MJPEG streams in addition to the MPEG stream).</p> <p>If this option is not selected, then only 1 video stream will be pulled from the camera regardless of how many different formats would be needed.</p> <p>If it is selected then multiple streams will be pulled.</p> <p>Also consider the following checkboxes that define, which formats can be pulled from the camera.</p> <p>Please note: Multi-streaming has some important restrictions that depend heavily on the camera type. Please refer to the document <i>Thecus VisoGuard 4.3 Supported Video Sources</i> for details on restrictions.</p>
Allow JPEG streaming	<p>If your camera supports MJPEG video streaming, you can allow using this mode by selecting this checkbox.</p> <p>In one special case, VisoGuard will try to pull an MJPEG stream even if this checkbox is deselected. This is the case when iCAT video analytics is working on MPEG streams (e.g. for motion detection) and Multi stream allowed is selected. This special additional MJPEG stream in QVGA is used only for iCAT and helps to minimize server CPU load for iCAT processing (please refer also to <i>14.2.1 Considerations for setting up a system with iCAT</i> on page 101).</p>
Allow MPEG-4 streaming	<p>If your camera supports MPEG-4 video streaming, you can allow using this mode in the Online Monitor and the archive by marking this checkbox.</p> <p>Please note that platform restrictions may apply for this streaming mode (please refer to <i>2.1 Introduction to the VisoGuard client</i> on page 10).</p>

Field label	Your input
Allow H.264 streaming	<p>If your camera supports H.264 video streaming, you can allow using this mode in the Online Monitor and the archive by marking this checkbox.</p> <p>Please note that platform restrictions may apply for this streaming mode (please refer to <i>2.1 Introduction to the VisoGuard client</i> on page 10).</p>
Allow MxPEG streaming	<p>If your camera supports MxPEG video streaming, you can allow using this mode in the Online Monitor and the archive by marking this checkbox.</p> <p>Please note that platform restrictions may apply for this streaming mode (please refer to <i>2.1 Introduction to the VisoGuard client</i> on page 10).</p>
Stream MPEG-4 via Multicast	<p>This option should only be switched on in very special situations. When marked then the MPEG-4 stream from the camera is received via "multicast", when disabled via "RTSP over HTTP". Multicast is a one-to-many, while RTSP is one-to-one type connection.</p> <p>Mark this checkbox only if you want to have multicast MPEG-4 streaming of the camera. In most cases you want to leave this checkbox not marked, which means that the MPEG-4 stream is transmitted via RTSP over HTTP.</p>
Allow Audio to camera	<p>When marked, VisoGuard will allow Audio to the camera and will offer a button for that in the Online Monitor. Of course this feature only works if you have a working microphone connected to the PC where you run your client on and your camera has a loudspeaker function.</p>
Allow Audio from camera	<p>When marked, VisoGuard will allow Audio from the camera to your client (in the Online Monitor and for recordings). Of course this feature only works if you have a working loudspeaker connected to the PC where you run your client on. Please note that platform restrictions may apply for this streaming mode (please refer to <i>2.1 Introduction to the VisoGuard client</i> on page 10).</p>
Audio from and to share single button	<p>If this checkbox is marked, then there is only one button in the Online Monitor that switches MPEG and Audio on and off. If this checkbox is not marked, then you will find 3 buttons for the three functions. See also <i>5.9 Working with MPEG cameras and audio</i> () on page 42.</p>
Anonymize (distort) audio	<p>In some cases Laws do not allow the transmission or recording of people's voices. The criterion often is whether one can recognize a person by listening to its voice. Therefore VisoGuard allows anonymizing the audio stream by distorting it. If this checkbox is marked then the live and recorded audio will be anonymized (distorted).</p>

The **Default settings for MPEG-4, H.264, MxPEG** and **Default settings for single-stream JPEG cameras** define the streaming format for the various streaming types. These settings will

be used in the **Online Monitor** and also for recordings. For multi-stream JPEG cameras, the **Default settings for single-stream JPEG cameras** are of no importance (because for each view port in the Online Monitor and also for recording separate formats can be specified).

Please note: In the current version, VisoGuard only supports 1 streaming format for MPEG cameras for live viewing and recording.

Field label	Your input
Use these settings	<p>Usually this checkbox must be set. It defines whether the default camera settings are set via VisoGuard or in the camera directly (via its own setting utilities). When it is switched on, the settings in the camera are overwritten by the values of this dialog. When it is switched off, the values from the camera are taken and the settings in VisoGuard are ignored.</p> <p>In very special situations only, e.g. when setting the values by VisoGuard causes some unwanted side effects in the camera, you may want to set the values in the camera directly and switch off this check box.</p>
Image quality	<p>Defines the image quality of the stream. The possible values are High, Medium, and Low quality. The higher the quality, the more bandwidth will be used for transmission and the bigger the space requirements for recording will be (see also <i>1.4 Video streaming methods and compression</i> on page 6).</p> <p>For multi-stream JPEG cameras, this value cannot be set here, since separate image qualities can be set for recording and in each view port in the Online Monitor.</p>
Image size	<p>Defines the image size of the stream. Possible values depend on the camera model. The bigger the image size, the more bandwidth will be used for transmission and the more space for recording will be needed.</p> <p>For multi-stream JPEG cameras, this value is of no importance, since separate image sizes can be set for recording and in each view port in the Online Monitor.</p>
Frame rate	<p>Defines the frame rate of the stream. Possible values depend on the camera model. The bigger the frame rate, the more bandwidth will be used for transmission and the more space for recording will be needed.</p> <p>For single-stream JPEG cameras, this value defines the maximum possible frame rate. In the Online monitor and for recording lower frame rates can be selected.</p>
GOP size	<p>For MPEG streams defines the how many frames are sent and stored in a GOP (group of pictures). One GOP is an integral data packet that is transmitted and recorded. Our default value is 10, which means that there is 1 reference frame (I frame) and 9 difference frames (P frames). A bigger GOP size means a higher compression rate but also a somewhat lower quality and a bigger delay between a real scene and its viewed images (which is relevant, e.g. for live viewing in the Online Monitor). We think that a GOP size of 10 is optimal for most case, which, dependent on camera model, covers a time between 0.5 ~ 1 sec.</p>

Field label	Your input
Bandwidth limit (Kbps)	<p>This setting limits the maximum bandwidth in kilobits per second for the transmission of MPEG streams between the camera and the server. As a consequence, also the bandwidth between the server and the clients is thus limited and also the required storage in the archive is influenced (limited). If this value is zero, then the bandwidth is not limited.</p> <p>This actually is a setting in the camera. The camera always optimizes for the desired image quality and will sacrifice frame rate in favor of quality in the case, the bandwidth would exceed the supplied limit.</p>

Fields for **In-camera motion detection** (please refer to *7.3 In-camera motion detection* on page 61 for further details):

Field label	Your input
Receive event images via FTP	If this checkbox is marked, you enable the In-camera motion detection and tell VisoGuard to receive event images via FTP. Please be aware that if you select this checkbox, the server-based motion detection must be disabled.
Receive event images via HTTP	The same as above, just that the images are received via HTTP protocol (some cameras support only HTTP).
Post recording length (sec)	When VisoGuard receives an in-camera event, then it can start a parallel server-side recording in addition to the event images it receives from the camera. The event images received from the camera via FTP/HTTP are merged with this server-side recording. This field defines how long this parallel post-event recording is. If it set to 0, then VisoGuard does not start its own server-side recording of images and just stores the event images it receives from the camera via FTP/HTTP.
Recording frequency	This field defines the recording frequency of the above mentioned parallel server-side post-event recording.

5. Push the **Next** button at the bottom of the dialog. This invokes the **Scheduling** dialog. Please refer to *6.1 Programming archive recordings* on page 45 on how to set up the camera archive and scheduling.
6. Optional: Push the **Next** button again at the bottom of the dialog. This invokes the **I/O Control** dialog that lets you define the handling of optional I/O contacts of your camera. If you do not want to use I/O contacts you can just jump to the next step.

Set your values:

Field label	Your input
Input handling enabled	Select this check box if you want to process the state of the digital input-contact port of the camera.

Field label	Your input
Input poll interval (msec)	The poll interval defines how often the state of the input port is checked. Minimum time is 500 milliseconds.
Output handling enabled	Select this check box if you want to enable switching the digital output port of the camera from within view port menu.

7. Push the **Save** button at the bottom of the dialog.

3.2.2 Duplicating an existing camera

Duplicating an existing camera creates an exact duplicate of the camera with all settings copied. This is useful when you have more than one camera of the same type or with equal/similar settings (like recording or video analytics settings).

With duplicating camera you can dramatically reduce the set up time for systems with many cameras with similar settings.

Here is how you can do that:

1. Choose **Camera admin** from the **System administration** menu. This opens the **Camera admin** dialog.
2. In the camera tree select the camera you would like to clone.
3. Choose **Duplicate camera** from the menu.

Now a new camera named as the existing camera with "(copy)" appended has been created.

4. Set the basic properties like name and IP address.
5. Optionally modify other parameters as needed (see *3.2.1 Adding a camera from scratch* on page 21 for details).
6. Push the **Save** button at the bottom of the dialog.

3.3 Setting up the camera recording archive

The configuration of camera recordings is covered in section *6.1 Programming archive recordings* on page 45.

3.4 Optional: Configuring video analytics (iCAT)

The configuration of video analytics with iCAT is covered in chapter *14 Video analytics with iCAT* on page 100.

3.5 Defining brightness, contrast, and saturation

If you are not satisfied with the brightness, contrast or saturation of camera video images then you can modify them. For IP cameras and analog cameras there are two different ways of modifying those video parameters:

- **IP cameras:** Each IP camera has its own setup interface (usually available via web browser) to define / modify the video parameters. Please consult the admin / setup manual of the IP camera.
- **Analog cameras:** VisoGuard allows you to define video parameters via the System Admin menu. Please see below for details.

3.5.1 Defining video parameters for analog cameras

1. Choose **Camera admin** from the **System administration** menu. This opens the **Camera admin** dialog.
2. Select the camera in the camera tree for which you want to set the image values.
3. Press the **Next** button 4 times (starting from basic properties to scheduling to I/O control to Image settings). Now you should see the **Video parameters** dialog:

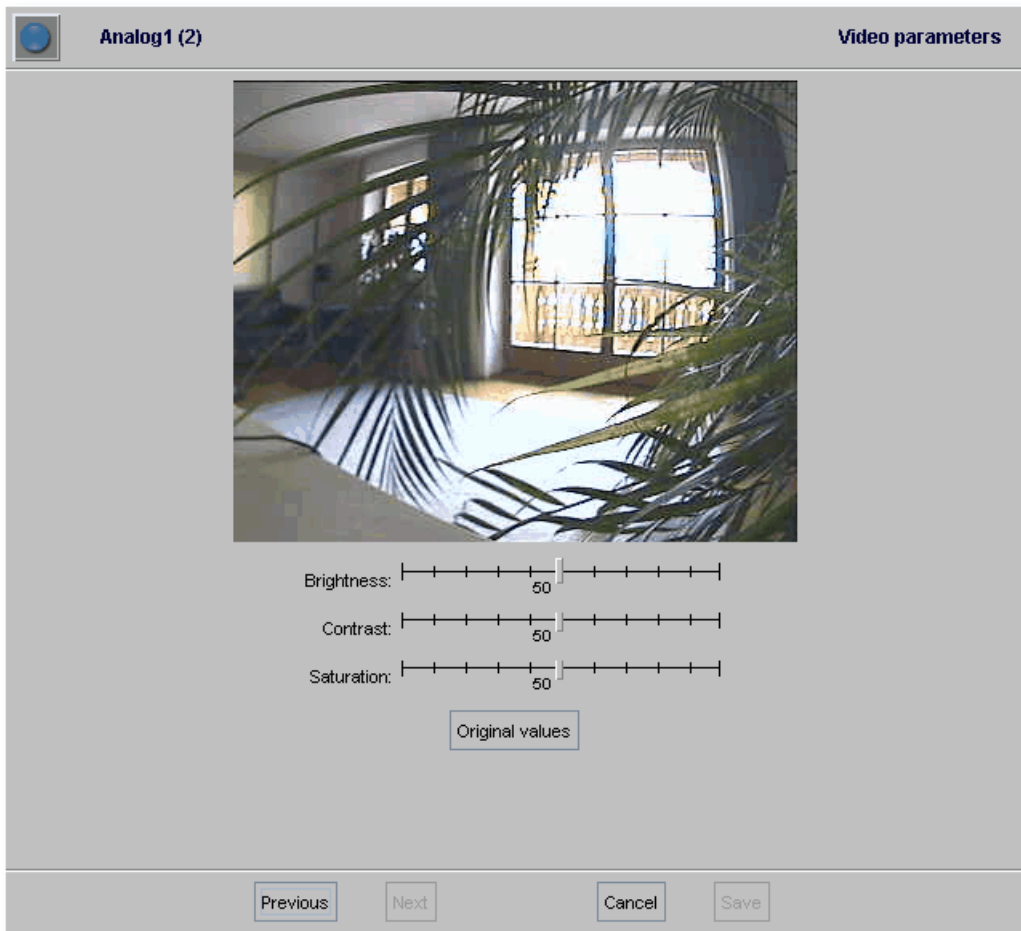

4. In the menu select **Modify selected camera or group** and then modify the brightness, Contrast and Saturation values according to your needs. Please be aware that light conditions may change during the day.
5. To store the settings press **Save**.

3.6 Working with camera groups

Camera groups are a powerful means for managing and organizing cameras.

3.6.1 Creating a new camera group

1. Choose **Camera admin** from the **System administration** menu. This opens the **Camera admin** dialog.
2. In the camera tree select the group in which you want to create the new camera group.
3. In the menu select **Add new camera group** which will open new dialog that allows you to enter the name and description for the new camera group.

4. Optionally select the **Use group name as camera name qualifier** checkbox. If this checkbox is selected then the name of the camera group is displayed as prefix to the camera name, e.g. "group-name:camera-name".
5. Press **Save** to create the new camera group.

3.6.2 Moving a camera or camera group in the camera tree

A camera or a group of cameras in the camera tree can be moved to another location by following these steps:

1. Choose **Camera admin** from the **System administration** menu. This opens the **Camera admin** dialog.
2. With a mouse click choose the camera or group you want to move.
3. In the menu select **Move camera or group**.
A new dialog appears that requires you to enter the password.
4. Enter the password.
After you enter the correct password a camera group dialog is opened showing the camera groups.
5. In the newly opened camera groups dialog select the group where you want to move the camera or group to and press **Select**.
Now the camera or group is moved to the new location and the camera tree is updated.

3.7 Changing the port mapping of analog cameras

This section is only valid for analog cameras. For analog cameras a port must be defined where the camera is connected to at the video capture card or the video server.

Sometimes the port mapping of analog cameras needs to be changed but it is difficult to do that physically by changing the cabling. To help the situation, VisoGuard can change the port mapping in the software.

There are two ways for doing that:

- Either go to the **Camera Administration** and manually switch the port there. For this however you need to know exactly which camera is connected to which port.
- You can also swap the ports in the **Online Monitor**. This has the advantage that you see the video pictures and therefore you can identify the correct ports visually.

In order to swap the ports of two analog cameras visually please follow these steps:

1. In the **Online Monitor** go to the view that shows the first analog camera in a view port.
2. CTRL-click into the view port that shows the first analog camera.
3. Now go to the view that shows the camera that you would like to swap with and CTRL-click in the view port.

Now the ports of the two cameras have been swapped.

4 Managing users

VisoGuard requires users to login in order to work with the system. This chapter describes how to create and manage users in VisoGuard.

Generally, you can either

- use VisoGuard to administer users (see *4.1 Creating a new user account* on page 30), or
- utilize Active directory or LDAP to manage users (see *4.8 Working with users from Active Directory or LDAP* on page 33).

4.1 Creating a new user account

An VisoGuard administrator can create user accounts in the system.

Please note: At initial product installation of a set of predefined users accounts and groups are created. These users and groups model typical permissions of users in various roles. Instead of creating a new user account you can take one of these predefined users and modify the settings accordingly.

Here are the steps for creating a new user account:

1. Choose **User admin** from the **System administration** menu. This opens the **User admin** dialog.
2. Select a user group to which you want to add the user. Please refer to *4.4 Working with user groups* on page 32 if you want to create a new user group first.
3. In the menu select **Add new user**. The **Properties** dialog opens to allow you to enter user data.
4. Enter your user data in the corresponding fields of the dialog. Use the following table as a guide. Fields labeled in **bold** (both in the dialog and in the table) are **mandatory**; all others are optional:

Field label	Your input
Login name	This is a short name that the user will use to log in.
Full user name	This is the complete name of the user.
Password	Enter a password for the user. The user can change this later on (see <i>4.7 Changing the password</i> on page 33).
Re-enter password	Enter the password again for verification.
Secondary password	Enable the checkbox and enter a secondary password if a secondary password is needed for logging in the user. This is important for enforcing the four-eyes principle for certain video operations.
Re-enter sec. password	Enter the secondary password again for verification.
Forgot question	Formulate a question that (only) the user can answer if he has forgotten his password.

Field label	Your input
Forgot answer	Provide the answer to the above password question.
SMS number	<p>If the user is to receive an SMS in the event of an alarm or failure, provide his cell phone number. Please insert a full international number starting with a '+'. Example: +43 123 456 7890.</p> <p>Please note that an SMS sending device has to be connected to the VisoGuard server for this feature to work. Refer to the manual <i>Thecus VisoGuard 4.3 Server Installation and Administration</i> for information about supported devices and how to connect and setup them.</p>
E-mail address	If the user is to receive an e-mail in the event of an alarm or failure, provide his e-mail address.
Language	Specify the preferred language for this user.
Auto login after 1 min timeout	Defines whether this user should be logged in automatically when nobody else logs at the login panel in for 1 minute. This option can be enabled for only one user at a time.
PTZ priority (1=lowest, 10=highest)	Defines the relative PTZ priority between users. A user with higher priority can take away PTZ control from a user with lower priority. Please note: The automated PTZ actions started by the event manager and scheduled routes have priority 4. Therefore users with priority 1 to 3 will be overridden by automatic PTZ actions, whereby users with priority 5 to 10 can override automatic PTZ actions but will not be interrupted by them.
Max. PTZ use time (sec)	Maximum allocation time, after which a PTZ camera is automatically released. Zero means no limit.
PTZ inactivity timeout (sec)	When a user has taken PTZ control and is inactive for a certain amount of time, the PTZ camera is freed automatically after this timeout. Zero means no timeout.

5. Push **Next** to go the **Privileges** dialog. Here set the privileges for the new user (see *4.2 Setting general user privileges* on page 31 for details).
6. Push **Next** to go the **Camera Access Rights** dialog. Here set the camera access rights for the new user (see *4.3 Setting camera access rights* on page 32 for details).
7. Push **Save** to create the new user account with the settings you entered.

4.2 Setting general user privileges

For each user and group certain privileges can be defined. These privileges define to which tools and data a user has access and what he can do.

1. Choose **User admin** from the **System administration** menu. This opens the **User admin** dialog.
2. Select the user or group you want to modify.
3. Click on the **Next** button to move to the **Privileges** dialog. Here you can edit privileges for the user or group. In their initial state, all privileges in this dialog are inherited from the upper group level. Inherited privileges from the group level to which the user or group belongs are displayed

with normal font, while values that you define at the current user or group level are displayed in **bold**.

Use the scroll bar to access the lower part of the list.

4. Choose **Modify selected user or group** from the menu.
5. Set the privileges according to your needs. To change a privilege click on its button and select the status from the pop-up menu (either **Inherited**, **Enabled**, or **Disabled**).
To set privileges for all users in the system you can select and modify the root group (but please be aware that at each group or user level privileges can be overridden).
6. Push **Save** to save your changes.

4.3 Setting camera access rights

1. Choose **User admin** from the **System administration** menu. This opens the **User admin** dialog.
2. Select the user or group you want to modify.
3. Click the **Next** button twice to get to the **Camera Access Rights** dialog.

Analog to the user privileges the camera access rights are inherited from the upper group level. Inherited access rights from the group to which the camera or camera group belongs are displayed with normal font, while values that are defined at the current level are displayed in **bold**.

4. Select the camera or camera group you want to look at or modify.
5. Choose **Modify selected user or group** from the menu.
6. Set the rights according to your needs.
To set access rights for the selected user or group for all cameras in the system you can select and modify the root camera group.
7. Push **Save** to save your changes.

4.4 Working with user groups

User groups are a powerful means to manage and organize users. For instance, you can set privileges for groups that are then inherited by the users belonging to this group.

4.4.1 Creating a user group

1. Choose **User admin** from the **System administration** menu. This opens the **User admin** dialog.
2. In the list of users and groups, select a user group to which you want to add a new group.
3. In the menu select **Add new group** which will open the new group dialog that allows you to define a **Group name**.
4. Press Next to edit the group **Privileges**. The privileges are the same as for a user. Inherited privileges are displayed in normal font while privileges defined at this group (level) are displayed in bold font.
5. Press **Save** to create the new group.

4.5 Defining Online Monitor views for a new user

If a new user needs to work in the Online Monitor then camera views need to be defined. Generally, there are 2 ways for doing that:

- Login as the new user and manually create new views as described under *5.1 Creating a new view* on page 35, or

- copy existing views from another administration user as described under *5.8 Copying views between users* on page 42.

4.6 Information about logged-in users

VisoGuard allows you to get information about logged-in users:

1. Choose **Users...** from the **System administration** menu. Now you see the list of logged-in users with information about the host from which the user logged in, login time, total bytes transmitted since login, and bandwidth.

4.7 Changing the password

This section describes how to change passwords for users defined in VisoGuard. For users defined in Active Directory/LDAP, the passwords need to be changed there.

Each VisoGuard administrator with the appropriate privileges can change the passwords of other users (see also *4.1 Creating a new user account* on page 30).

Additionally, each user can change his own password by following these steps:

1. In the **VisoGuard** menu choose **Change password...**
2. In the newly opened dialog enter the old (current) password and the new password twice.
3. Push **OK** to change the password. When you login the next time, you will have to enter the new password.

Please note: The optional secondary password can only be changed by an VisoGuard administrator with the appropriate privileges.

4.8 Working with users from Active Directory or LDAP

You can configure your VisoGuard server to import users from an Active Directory (AD)/LDAP server. In this case the users (user names and passwords) are maintained in AD/LDAP and users are imported (mapped) to a user group in VisoGuard. The privileges of these users (what they are allowed to do in VisoGuard) are defined at the VisoGuard user group where they belong to.

4.8.1 How VisoGuard and Active Directory/LDAP work together

When an connection to an Active Directory/LDAP server is set up correctly, VisoGuard imports users of a matched group in Active Directory/LDAP. These users are imported to a certain user group in VisoGuard. The privileges and camera access rights of the users imported from Active can be defined at the user group in VisoGuard.

When the VisoGuard server connects the Active Directory/LDAP server the first time, it loads all matched users into the user group in VisoGuard. These users are then cached in VisoGuard (no user passwords are stored in VisoGuard). Each 2 minutes the list of users is reloaded from the Active Directory/LDAP server.

Each time when a user that is defined in Active Directory/LDAP logs in to VisoGuard the password is checked (authenticated) with the Active Directory/LDAP server. This means that at login time an active connection to the Active Directory/LDAP server must be present.

Also note that no VisoGuard-specific information is stored in Active Directory/LDAP.

4.8.2 Setting up an Active Directory/LDAP connection

First you need to define a user group to which you want to import the AD/LDAP users:

1. Choose **User admin** from the **System administration** menu. This opens the **User admin** dialog.
2. In the user tree select a group that should serve as the container for the users imported from AD/LDAP. The group must be empty, it must not contain any local users.
If you do not have an appropriate group, you can create a new user group by selecting the parent group under which you want to create the new user group. Then choose **Add new group** from the menu, supply a name, and push **Save**.
3. Choose **Modify selected user or group** from the menu.
4. Select the check box **Users of this group are imported from Active Directory**.
5. Now you can define the privileges and camera access rights of the imported users by going to the **Privileges** dialog and the **Camera access rights** dialog (push the **Next** button to move to these dialogs).
6. Push **Save**.

Once you have enabled a group for AD/LDAP import you must setup the connection to an AD/LDAP server:

1. Choose **Active directory configuration** from the menu. This opens the **Active directory configuration** dialog (this dialog actually is part of the **Host admin** dialog). In this dialog you can
 - define the connection to an AD/LDAP server
 - define an AD/LDAP filter to match a certain AD group (set of users) for importing to VisoGuard
 - define the Tag mapping between AD/LDAP and VisoGuard
2. Choose **Modify host** from the menu.
3. Under **Connection parameters** define the filters for matching a certain AD group (set of users) for importing to VisoGuard.
Under **Observer group name** you must enter the name of a user group in VisoGuard for which you enabled the **Users of this group are imported from Active Directory**. Please note that AD servers usually can be accessed at **Port 389**.
With **Test connection** you can check whether the server can be accessed with these values.
4. Under **Directory parameters** define the AD/LDAP filters to match a certain AD group (set of users) for importing to VisoGuard. The filter fields **Search base**, **AD group name**, **Directory address** are available for further constraining the matched user group in AD and need to contain the fully qualified strings in AD (e.g. OU=Video-users, DC=netavis, DC=net).

In **Observer group name** please add the name of the VisoGuard group where the users are to be imported.

Select or create the appropriate **Attribute mapping schema**. The attribute mapping defines what AD attributes are mapped to which VisoGuard attributes. Usually these are the mappings:

For Active Directory:

Attribute	Value
Login name tag	cn
Name tag	displayName
SMS number tag	telephoneNumber
Email tag	mail

The **Tag mapping** defines further attribute mappings. For Active directory the **AD group identifier tag** must be set to `memberOf` and **Login name tag** must be set to `cn`.

5. Push **Save**.

Now the users from AD/LDAP should be imported to the specified user group in VisoGuard.

5 Using the Online monitor

In the **Online monitor** you can view live streams from cameras that are set up at the VisoGuard server. The prerequisite is that you must have authorization to access the Online Monitor (see 4.2 *Setting general user privileges* on page 31). Furthermore, you can access only those cameras for which you have access rights (see 4.3 *Setting camera access rights* on page 32).

When a new user logs in the first time he will encounter an empty Online monitor waiting for new camera views to be defined. Once you have defined your views they will reappear next time you log in.

You can also have several Online monitors in multiple windows (see 2.4 *Client multi-window and multi-screen operation* on page 17).

Important: If you are using a low-bandwidth connection between client and server (e.g. via wide area networks) it can happen easily that the video streams cannot pass through the connection fast enough, which results in bad frame rates and slow responsiveness of the client. In such a case you should use the Transcoding™ feature of VisoGuard. See 2.5 *VisoGuard Transcoding™ for low-bandwidth client-server connections (ABS)* on page 19 for further details.

5.1 Creating a new view

VisoGuard lets you create an unlimited number of named views. Each of these views can contain up to 100 camera view ports.

1. Choose **Create new view** (either from the empty Online monitor or from the **Control menu**) to open the **Create new view** dialog.
2. You can now choose the layout for your view from predefined templates and you also can define an arbitrary matrix of up to 10 x 10 views. A new dialog is opened asking for the name of the view and the aspect ratio for the view ports.

The **Name of view** is shown in the view selector at the top of the screen. Please note that you can also create a view hierarchy by using a colon between the names. In the example below we created a view in the group called "First floor" with a name "Entrance hall". There might also be a view called "Office 1" or "Kitchen".

The **Aspect ratio** pop-up defines the aspect ratio of the view ports in the view:

- o Fixed aspect ratios: PAL, NTSC, VGA, double VGA, or HDTV 16:9.
- o **Fill available space:** This is the default setting and will adapt the view port size (and hence the aspect ratio) to fill the available space.
- o **Custom aspect ratio:** here you can freely define an N:M aspect ratio.

The setting **Stretch image to fit into view port** (selected by default) defines whether a camera image can be stretched to fit into the view port. This may cause distorted images for aspect ratios that do not fit the current view port aspect ratios.

The setting **Crop image to fit into view port** defines whether a camera image can be cropped to fit into the view port. This may cause that some parts of the image are not visible in the view port. In the section 5.4 *Modifying view port settings* on page 38 you can define what part of the cropped camera image is to be shown in the view port.

Please select an aspect ratio that fits most of your cameras you plan to show in the view. Selecting an improper aspect ratio can lead to unused space on the screen.

Press **OK** to acknowledge your input.

3. In accordance with the selection above, VisoGuard creates a new view that might look as follows (your view may have a different number of view ports depending on what you selected):

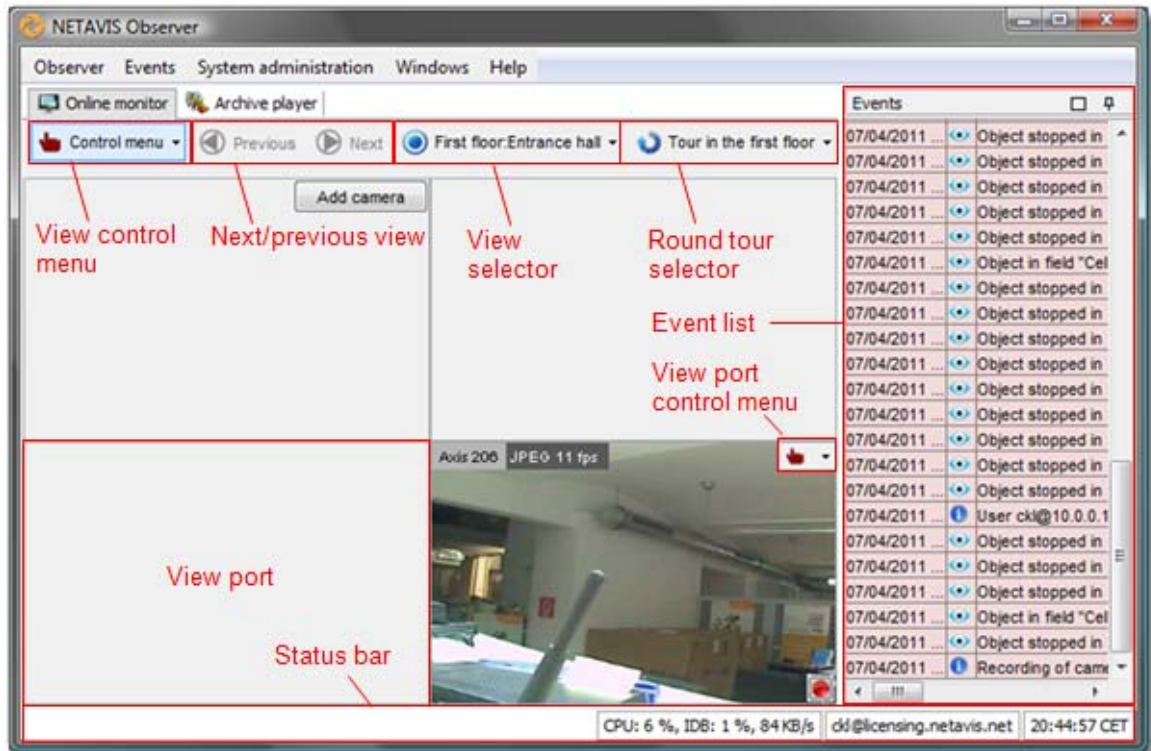

The view ports fill the central part of the window, and each view port has its own view port controls.

At the right side of the window is the **Event list**, which is explained in *8 Handling events* on page 63.

4. Choose **Save all view settings** from the menu in order to save all settings for your current user. The next time you log on to VisoGuard, all views will then be available again. If you neglect to save, all changes are lost when you exit the application.

Please note: All view settings will be stored, also quality and fps settings of view ports. New views will be stored automatically without the need to save manually.

5.2 Selecting cameras

1. In the view port push the **Add camera** button. Please note that you first have to set up a camera before you can select it in one of the view ports (see *3 Setting up cameras* on page 21). This opens the camera tree.
2. Select a camera from the newly opened camera tree.

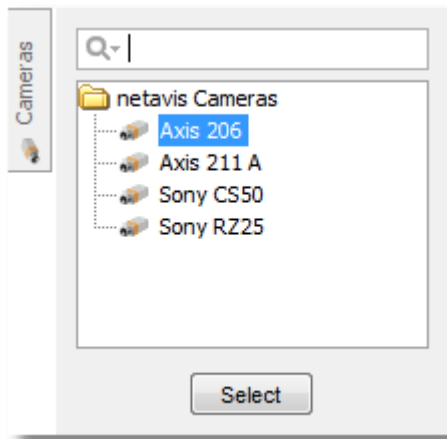

You can either:

- o select a camera and push the **Select** button, or
 - o double click on a camera to add it to the view port where you pushed **Add camera**, or
 - o drag and drop a camera to the view port of your choice
3. Proceed in the same way with additional view ports in your view.
 4. You can assign multiple cameras to each view port. However, since you can only view one camera image in each view port, VisoGuard lets you manually switch between cameras by clicking on the camera selection menu at the upper left corner of the view port.



5. In the camera selection menu of a view port you can also select the option **Shuffle**. Then VisoGuard cyclically switches through all the cameras assigned to the view port.
6. Please select **Save all view settings** from the view **Control menu** in order to save all settings. The next time you log in to VisoGuard, all views and view ports will be available again.

5.3 Navigating in the Online monitor

You have several options for navigating in the Online monitor:

- Select a view from the **View selector** pop-up.
- Select a Round tour from the **Round tour selector** pop-up.
- Use the **next/previous view** buttons to navigate to the previously displayed views.
- Double click in a view port to get a big view of the actually displayed camera in the view port. If there is a view defined containing a big view port with the camera, then this view will be

exposed. Otherwise a new temporary view with the camera will be created. You can then go back to the previous view by pushing previous view button.

- Use the quick **Camera finder**: You can just start typing at your keyboard. A little **Camera finder** pop-up will show at the lower right corner of the client window and will show a list of cameras with matching names and ids:

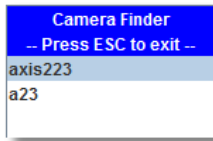

You can double click a camera or select it with the keyboard and press **ENTER**, which will expose a big view of the camera (which is the same action as a double click in the view port). The behavior of the action can be customized (see document *Thecus VisoGuard 4.3 Server Customizing*).

5.4 Modifying view port settings

VisoGuard allows you to set various options including video quality of either single view ports or all view ports in the current view at once.

The settings of a single view port can be modified via the view port's control menu  that appears in the upper right corner of a view port when you move the mouse pointer over the view port.

The view port control menu offers the following options:

5.4.1 Adding and removing cameras

Cameras can be added and removed with the **Add camera** and **Remove camera** menu entries. Please refer to section 5.2 *Selecting cameras* on page 36 for more details.

5.4.2 Controlling PTZ cameras

The **PTZ** menu allows PTZ control and is enabled for PTZ cameras (see 9.4.1 *Controlling PTZ cameras in the Online monitor* on page 70).

5.4.3 Setting video parameters

The **Video parameters** menu offers the following options:

Set streaming format	defines how the camera images should be streamed. The available options depend on your camera and your setup of the cameras inside VisoGuard (see 3.2 <i>Adding a new camera and setting basic properties</i> on page 21). Please refer also to 1.4 <i>Video streaming methods and compression</i> on page 6 for further details on streaming formats.
Set image quality	sets the quality of the streamed images by modifying the compression rate. The options are High , Medium and Low . Refer to 1.4.5 <i>JPEG image sizes and storage requirements</i> on page 8 for details on these values.
Set image size	sets the image size of the streamed images. The available size options are camera-specific. Please refer to your camera's manual. Please note that for MPEG cameras you cannot change the size of streamed images. The sizes of streamed MPEG
Set frame rate	sets the frame rate of the video stream. The options are Max fps , various fps and fpm values and Stop .

Set camera name appearance	defines the position where the camera name is displayed in the view port.
Rendering preference	defines which scaling algorithm will be used when images need to be scaled to fit the available view port space. In the Optimized for speed means that the scaling is done with a faster algorithm that may cause lines to be not so smooth. Optimized for quality means that the scaling is done with a more CPU-intensive anti-aliasing which causes straight lines to be smoother.

These settings can be modified all at once for all view ports in the current view via the **Set parameters of all view ports** from the view **Control menu**. Holding down the **CTRL** key while selecting any of the **Set parameters of all view ports** commands will modify all view ports of all views (not just the current view).

5.4.4 Controlling video analysis (iCAT) display

The iCAT menu offers various options for displaying iCAT-related video analysis information. Please refer to *14.4 Working with iCAT* on page 117 for further information.

5.4.5 Defining a crop area

For views where you have the **Crop image to fit view port** setting selected, you can define what part of the cropped camera image you want to see by choosing **Define crop area...** from the menu.

5.5 Zooming in a view port and in archive recordings

VisoGuard allows you to zoom view ports in the Online monitor and in the Archive player.

Basically, you have two ways to zoom a view port or a recording in the Archive player:

5.5.1 Zooming with the mouse wheel

1. Just move the mouse pointer over a view port and turn the mouse wheel. The view port will zoom accordingly.
2. You can move the zoomed area in a view port by dragging it with the mouse.
3. Use the mouse wheel again to zoom out.

5.5.2 Zooming by drawing a zoom rectangle

1. With the mouse draw a rectangle in a view port.
2. Click in this rectangle, which will cause the view port to zoom accordingly.
3. You can position the zoom by dragging the rectangle. You can also modify its size by turning the mouse wheel.
4. Click outside the rectangle to return to normal (not zoomed) view.
5. You can remove the zoom rectangle by clicking into it with the mouse and pressing the **Delete** or **Backspace** key. Alternatively, you can drag the rectangle outside of the view port to remove it.

You can also have multiple zooming rectangles per view port.

Showing a zoomed view in another view port (Online monitor only)

1. Draw a zoom rectangle with the mouse.
2. Click into another view port. Now the zoomed area is shown in the other view port.
3. You can position the zoom by dragging the rectangle.

4. You can remove the zoom by clicking the rectangle with the mouse and pressing the **Delete** or **Backspace** key. Alternatively, you can drag the rectangle outside of the view port to remove it. Removing a rectangle will also remove the zoomed view from the other view port.

Please note: When PTZ control is enabled, any mouse actions are taken for PTZ control. In order to control the view port zooming, hold down the **CTRL** key while using the mouse.

5.6 Manual recording control in the Online Monitor

In addition to programmed recordings, you can also manually start and stop continuous recordings directly in the Online monitor. When manual recording control is set up, a recording button is shown in camera view ports in the Online monitor.

5.6.1 Setting up manual recording control

To enable recording control, you must do 2 things:

- Enable the manual recording camera access right for the user
- Set up a continuous recording schedule for the camera. The continuous recording schedule that is active at the time when the user pushes the manual recording button defines the format of the recording. Therefore you can also have different manual recording formats for different times in the day or week.

Enable the manual recording camera access right

Here is how to set the camera access right for manual recording (see *4.3 Setting camera access rights* on page 32 for a general description on how to set camera access rights):

1. Login as administrator user (or another user with the right to modify user data).
2. Choose **User admin** from the **System administration** menu. This opens the **User admin** dialog.
3. Select the user or group for which you want to enable manual recording control.
4. Click the **Next** button twice to get to the **Camera Access Rights** dialog.
5. Select the camera or camera group for which you want to enable manual recording control.
6. Choose **Modify selected user or group** from the menu.
7. Enable the right **Manual recording control from Online monitor** by choosing **Enabled** from the pop-up menu.
8. Push **Save** to save your changes.

Set up a continuous recording schedule

In order to use manual recording control for a camera you have to define a continuous recording schedule (please refer to *6.1.1 Programming continuous timed recordings* on page 45 for a general description of setting up schedules for continuous recordings):

1. Choose **Camera admin** from the **System administration** menu. This opens the **Camera admin** dialog.
2. In the camera tree select the camera for which you want to set up the recording schedule.
3. At the bottom of the screen, click on the **Next** button twice. This takes you to the **Scheduling** dialog. If you are setting up a new camera, this dialog will be quite empty.
4. In the menu select **Modify selected camera or group**.
5. Click the **Add** button to add a schedule slot to the **Time Intervals** list.
6. Click the **Change** button and choose **Continuous recording**.
Now the **Scheduling** dialog shows the settings for configuring continuous recording.

- Now you can define the days and times for the recordings. You can activate individual days or, with the **All** button, the whole week at once. Select hours and minutes from the popup matrix. If you want that recording can only be started manually then make sure that the **Enable interval** checkbox is disabled.

Note: When a user pushes the manual recording button in the Online monitor actually the **Enable interval** checkbox is toggled. This causes the recording to either start or stop.

- Set all the recording options as described in *6.1.1 Programming continuous timed recordings* on page 45.
- Click on **Save** to save your settings.

5.6.2 Manually controlling recordings in the Online monitor

When everything is set up as described above then for the enabled user and camera a manual recording button is shown in any view port displaying the camera.



You can switch recording on and off by pushing the manual recording button. The recording state is shown by the color (a strong red dot means recording is on, otherwise recording is off).

Please note: For times not covered by a continuous recording schedule no manual recording button is shown.

5.7 Working with round tours (the Smart guard™ function)

VisoGuard allows you to make virtual round tours of views. You can define round tours that contain certain views. When a tour is started, VisoGuard walks you through all the views by automatically showing up the views in the **Online monitor**. This is like a virtual patrol of a security guard (Smart guard™ function).

5.7.1 Defining a round tour

Steps to add a new round tour:

- In the Online monitor choose **Round tours...** from the view **Control menu**. Now the **Round tours** dialog opens.
- In the **Round tours** dialog push the button **Add new round tour**.
- In the **Tour name** field enter the name of the round tour.
- Now you can select a view from the **Views** list and push the **▶▶** button to include it in the tour. By pushing the **◀◀** button you can remove a view from the tour. You reorder views in the tour by pushing the **Up ▲** and **Down ▼** buttons.

Please note: You can have the same view several times at different locations in a round tour. You can select multiple views in the **Views** list at once by holding the **CTRL** key while selecting the views.

5. For each view you can set a **Shuffle duration** that determines, how long (in seconds) this view is shown before VisoGuard automatically changes to the next view in the tour. By pushing **Set for all** you can set the same duration for all view in the round tour.
6. Push **Save** to save your changes and **OK** to leave the dialog.

Later on you can modify an existing round tour by opening the **Round tours** dialog and then choose an existing round tour from the **Round tours** list and push **Modify round tour**.

A tour can be deleted by opening the **Round tours** dialog and then choose an existing round tour from the **Round tours** list and push **Delete round tour**. Then you have to enter your password to confirm the delete.

5.7.2 Activating round tours

After you have defined a round tour, a new **Round tour** selector appears in the **Online monitor**. To activate the round tour, just choose its name from the **Round tour** selector. This activates the automatic walkthrough all of the views in the round tour (Smart Guard™ function). The name of the round tour now appears in green to show that it is active. You can stop the tour by choosing a view from the **View** selector (the **Round tour** selector will change its color to normal to show that no tour currently is active).

5.8 Copying views between users

If there are several users in a system it can be a lot of work to create views for each user individually. In order to help, VisoGuard offers the possibility to copy complete views (including all view settings) or even all views of an administrator user to another user. Important is that the user who copies the views to other users must have user administration rights („User admin: Access to User administration“ and „User admin: Manipulate user data“).

Here is how you can do that:

1. Login as the user from whom you want to copy the view(s) and go to the Online monitor.
2. Create/define the view(s) you want to copy. Please note that only saved settings are copied.
3. Select the view you want to copy and then choose **Copy current view to other users...** from the view **Control menu**. Now a user selection dialog opens.
4. Select the users to whom you want to copy the current view. Multiple users can be selected by holding down CTRL while clicking on user names. After you have finished selecting the users, press the **Select** button. Now the selected users receive a copy of the current view.

You can also copy all views of the current user by choosing **Copy all views to other users...**

If the users already have views with the same name as the copied views, then the existing views will be overwritten by the copied ones!

Please note: The user, who was copied to has to login again in order to see the newly copied views.

5.9 Working with MPEG cameras and audio (MPEG-4, H.264, and MxPEG)



Note: In the current version of VisoGuard, MPEG and bidirectional audio is only supported by clients running on MS Windows. For further details please refer to *2.1 Introduction to the VisoGuard client* on page 10.



VisoGuard also supports MPEG cameras (MPEG-4, H.264, and MxPEG) with audio streaming (see also *3.2 Adding a new camera and setting basic properties* on page 21).



If the camera allows MPEG streaming, you can select the MPEG streaming format from view port control menu. Once the MPEG streaming is activated, additional MPEG controls appear on the view port(s):



These controls allow you to see and modify Audio aspects:

Audio from the camera:  indicates that audio from the camera is on.  indicates that audio from the camera is off. A click on the icon turns it on or off.

Audio to the camera:  indicates that audio from your microphone to the camera is on.  indicates that audio from your microphone to the camera is off. A click on the icon turns it on or off.

If you have the **Default settings** in the **Camera Admin** set to **Audio from and to share single button** then you will see only one control icon: **Bidirectional Audio:**  indicates audio in both directions is on (loudspeaker and microphone is on).  indicated that audio in both directions is off (loudspeaker and microphone is off).

5.10 Dynamic Online monitor view control

VisoGuard allows you to dynamically control which cameras to display in the Online monitor by several powerful means:

- control views by iCAT events (motion detection, object triggers, sabotage detection, etc.)
- control views based on special logic (like the Matrix view function, see *15.4 Matrix view function of the Online monitor (VIP control)* on page 124).

The next sections describe how you can define these control mechanisms.

5.10.1 Controlling Online monitor views by iCAT events (motion detection, object triggers, etc.)

You can add special view control commands to any of the iCAT triggers like motion detection (MD), object triggers, sabotage detection, etc. Once the iCAT trigger is activated, the associated control commands are executed.

Here is how you can do that, assuming that you already have valid iCAT definitions:

1. Choose **Video analysis (iCAT)** from the **System administration** menu. This opens the **Video analysis (iCAT)** dialog.
2. Select a camera and for the camera select an iCAT trigger definition (simple motion detection, event trigger, sabotage detection, lighting change detection, removed/abandoned object).
3. Choose **Modify selected definition** from the menu.
4. In the **Comment** field add the following text:

pop: <mode>,<view-name>; <additional-camera-IDs>; <user-names>; <IP-addresses>

where:

<mode> is one of:

- **1:** shows the camera in a large view.

- **2:** shows the camera and optional **<additional-camera-IDs>** in the view named **<view-name>** (must be supplied). The cameras are placed in the "oldest" view ports (view ports that stood there the longest without a camera change). Thus you can create a view where always cameras with the newest events are displayed.
- **3:** shows the camera and optional **<additional-camera-IDs>** in the view named **<view-name>** (must be supplied). The cameras are placed row-wise starting at the top left view port. The cameras that were in these view port before are shifted to the right. Cameras at the lower right corner of the view therefore are removed from the view. Thus you can create a view where cameras with the most recent events are always displayed at the top left position.
- **4:** shows the camera and optional **<additional-camera-IDs>** in the view named **<view-name>** (must be supplied). The cameras are placed in empty view ports. They have a close button associated with them. When the user clicks the close button, the cameras are removed from the view, freeing the view port for another camera to be shown. Thus you can create a view where cameras with the most recent events are always displayed and stay there until they are removed by the user. Please note: When all view ports of the view are filled, no new cameras will be shown until a view port is freed.
- **5:** similar to mode 1 it shows the camera in a large view. The optional **<additional-camera-IDs>** are paired one-by-one with the **<user-names>**. This causes that these additional cameras are shown in large view at the clients where the supplied users are logged in.
- **6:** similar to mode 1 it shows the camera in a large view. The optional **<additional-camera-IDs>** are paired one-by-one with the in the **<IP-addresses>**. This causes that these additional cameras are shown in large view at the supplied clients workstations.

<additional-camera-IDs> is an optional comma-separated list of camera IDs which should be shown in addition to the camera that triggered the event.

<user-names> is an optional comma-separated list of user names to notify. If not defined, then all users are going to be notified.

<IP-addresses> is an optional comma-separated list of client workstation IP addresses to which the notification is sent. If not defined then all connected workstations are going to be notified.

Examples of directives to be used in any iCAT comment field

pop:1;;;

shows a live view of the camera which triggered the event in all connected client sessions.

pop:2,my-view;3,4;;

shows live view of camera which triggered the event and the cameras with IDs 3 and 4 in the view named "my-view" in all connected client sessions.

pop:3,my_fifo;3,4;mike;192.168.7.12

shows a live view of camera which triggered the event and the cameras with IDs 3 and 4 in the view named "my_fifo" where the IP address of the client workstation is 192.168.7.12 and user 'mike' is logged in.

pop:4,my_dynamic;3,4;;

shows live view of camera which triggered the event and the cameras with IDs 3 and 4 in the view named "my_dynamic" in all connected client sessions.

5. Push the **Save** button.

6 Working with archive recordings

This section shows you how to work with the VisoGuard recording archive, particularly in the following areas:

- Programming archive recordings (timed or triggered by iCAT (video analytics) events)
- Selection and playback of archive recordings

Please note: In order to work with archive recordings you need to have the appropriate user privileges and camera access rights (for further details see [4.2 Setting general user privileges](#) on page 31 and [4.3 Setting camera access rights](#) on page 32).

6.1 Programming archive recordings

Two types of programming are available in VisoGuard:

- timed recording
- recording on iCAT (video analysis) events like motion detection or people counting

To be able to program recordings, you need corresponding authorization.

6.1.1 Programming continuous timed recordings

1. Choose **Camera admin** from the **System administration** menu. This opens the **Camera admin** dialog.
2. In the camera tree select the camera for which you want to program archive recording. When you select the camera (highlighted in light blue), its data are displayed in the **Properties** dialog at the right side of the screen.
3. In the menu select **Modify selected camera or group**.
4. At the bottom of the screen, click on the **Next** button twice. This takes you to the **Scheduling** dialog. If you are setting up a new camera, this dialog will be quite empty.

Note: some fields and buttons are deactivated. Only when you select **Modify selected camera or group** in the menu they become editable. Also, the **Time Intervals** field is still empty when you begin. Later it will contain one or more program slots for the selected camera.

5. Click the **Add** button to add a programming slot to the **Time Intervals** list.

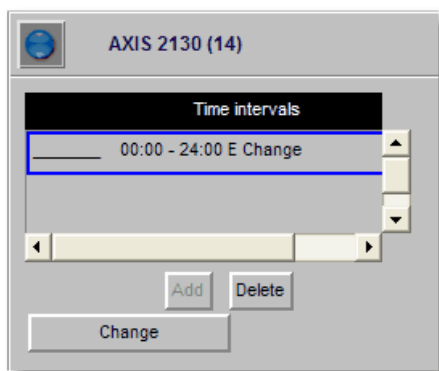

The new entry will be selected.

6. Click the **Change** button (now enabled) and choose **Continuous recording**. Now the **Scheduling** dialog shows the settings for configuring continuous recording:

7. Now you can define the days and times for archive recordings. You can activate individual days or, with the **All** button, the whole week at once. Select hours and minutes from the popup matrix. Please make sure that the **Enable interval** checkbox is marked, because only then are the settings enabled and recording is started.

Note: If you want to record at different times on different days, you can create multiple recording intervals. For each recording interval proceed as described here.

8. In addition to defining the weekdays and times, you need to specify the **Recording format**. If your camera also supports multiple formats you have several choices (for details on streaming formats please refer to *1.4 Video streaming methods and compression* on page 6):
- **JPEG stream** is also known as MJPEG, where the server stores sequences of JPEG images.
 - **MPEG-4 video** for MPEG-4 video streams.
 - **H.264 video** for H.264 video streams.
 - **MxPEG video** for MxPEG video streams.

For the MPEG video formats you can additionally select **Save audio**.

When you choose any of the MPEG video formats then the video settings that are defined in the camera's Default settings will be taken for recording (*3.2 Adding a new camera and setting basic properties* on page 21).

If you choose **JPEG stream** you can additionally set the **Image quality**, the **Frame rate** and the **Image size** for the archive recording:

Set the values according to your needs. See *1.4.5 JPEG image sizes and storage requirements* on page 8 for details on images sizes, quality, and storage requirements.

Note: Some cameras are only capable of a single picture stream which will constrain the possibility of recording in multiple formats and having different video stream settings in the Online Monitor and the recording. Please refer to the document *Thecus VisoGuard 4.3 Supported Video Sources* for information about supported cameras and their streaming capabilities.

9. Fill in the **Requested recording period** for this camera. This value defines how long VisoGuard will keep recordings. Recordings that are older than **Requested recording period** will be automatically deleted by VisoGuard (see also *6.1.3 Operation of the VisoGuard dynamic storage management* on page 47).

You can also select **Priority over other cameras (if storage space is short)** to give this camera priority over other cameras if the available storage space is too short for all requested recordings of all cameras (for further details see *6.1.3 Operation of the VisoGuard dynamic storage management* on page 47).

You can also define what the requested recording period refers to: either **Recording period is measured from now** or **Recording period is measured from youngest recording**. There can be quite a difference between these two choices for the following case: Assume a motion detection-based recording that only triggers recording once every few weeks.

Optionally, in order to save disk space, you can lower the frame rate of older parts of the archive. To do that click on **Reduced frame rate settings (JPEG only)...** to open a small dialog that allows you to enter a reduction period and a reduced frame rate.

For example, setting 30 days of **Requested recording period** with 25 fps and 20 days for reduced archive with 3 fps will maintain an archive containing recent 10 days with 25 fps and the remaining 20 days will be automatically reduced to 3 fps.

Please note that this works for JPEG streams only and does not affect any MPEG recordings.

Additionally, you can see the **Actual recording period (days/hours)**, the **Storage used by this camera (MB)**, the **Total storage space (MB)** which shows the overall storage space of the server, and the **Free storage space (MB)** which is the available space for new recordings on this server.

10. Click on **Save** to save your settings. As soon as the scheduled time is reached recording is started with these settings.

6.1.2 Scheduling video analysis (iCAT) operation and recording

For information on how to schedule video analysis (iCAT) operation and recording please refer to section *14.3.9 Scheduling iCAT operation and recording* on page 115.

6.1.3 Operation of the VisoGuard dynamic storage management

In the **Scheduling** dialog you can specify the **Requested recording period** property that defines how long recordings are to be kept by VisoGuard. Any recordings that are older than the requested recording period are automatically deleted as long as you do not manually protect them from deletion (see *6.2.8 Protection of recordings against automatic deletion* on page 53).

For cases like motion detection-based recording it can be very difficult if not impossible to estimate the required storage space and therefore space for all requested recordings could be too short. To help with this hopefully rare case, VisoGuard uses an intelligent storage management process. This process always tries to store all requested periods for all recorded cameras.

However, if there is not enough space available, the allocation process is doing two things:

- It generates a system event once a day and sends an email / SMS to the VisoGuard administrator telling him that there is not enough space for all recordings.
- It automatically truncates the recordings of cameras to allow a proportionally even distribution of the available space among all cameras.

For some special cameras that have to record the requested storage period in any circumstances, VisoGuard offers the **Priority over other cameras (if storage space is short)** flag. If this flag is set for a camera, VisoGuard always tries to store the requested period for this camera and truncates other cameras that do not have this flag set a little more. If there is more than 1 camera that has the flag set, the storage management process tries to store all of those cameras.

Algorithm of the dynamic storage management process:

Fill-time-percentage (FTP) = $100 * \text{Actual-recording-time} / \text{Requested-recording-time}$.

VisoGuard tries to keep the FTP of all cameras of each of the two priority classes the same (high-priority cameras and lower-priority cameras). First the algorithm tries to fully record the high-priority cameras and then use what is left for the lower-priority ones, whereby all of those will reach the same FTP. However, the low priority cameras can never go below an FTP of 10%. If the low priority cameras reach a level of 10%, then the storage management process starts truncating the archives of the high priority cameras as well. Anyway, this should never happen in a normal case and is only possible if the storage space is totally insufficient for holding the programmed recordings.

Since the storage management process considers recording time and not recording space for distributing the available space, it happens that the relatively small recording space of a camera with a low recording frame rate is truncated in the same proportion like the relatively big recording space of a camera with a high recording frame rate.

Caution: Please be careful when you set the **Priority over other cameras** flag since, if storage space is short, VisoGuard truncates the archives of all other cameras in favor of this camera. If available storage space is much too short relative to the requested storage periods of all cameras, this can lead to strongly truncated archives.

6.2 Playback of archive recordings

VisoGuard features a multitude of powerful functions for working with archives.

6.2.1 Selecting the camera and the playback period

1. Go to the main window and choose the **Archive player** (if the Archive player is not available, then perhaps it is disabled in the client preferences; see *2.4 Client multi-window and multi-screen operation* on page 17).

Either the **Camera tree** appears immediately or you have to push the **Select camera** button .

2. Select the camera from the camera tree and push **Select** (you can also double click a camera or drag it to the calendar view). An overview for the selected camera on the current day is displayed:

The screenshot shows the 'Player' tab in the software. At the top left, there are 'Calendar' and 'Player' tabs. Below them is a camera icon and the text 'Analog 1 (CET)'. To the right, there is a 'View: Day View' button. The main area is a grid representing a 24-hour period (0 to 23 on the y-axis) and 60 minutes (0 to 59 on the x-axis). Green blocks indicate recorded minutes. A mouse cursor is over a block at 15:44, which is highlighted with a white box. Below the grid, there are navigation arrows, the date '2007. February 27', and a 'Jump to Today' button. On the right, a 'Total images:' list shows the number of images recorded for each minute. A small video window in the bottom right corner shows a live feed of the camera's view.

This one-day overview shows green blocks indicating minutes for which recordings have been archived. A red corner in a block indicates that an event was triggered and an event recording was started in that minute.

When you move the mouse pointer over a green block, then the first recorded frame of this minute is displayed in the lower right corner of the window.

You can also switch to a monthly or an annual overview via the **View** button and its popup menu.

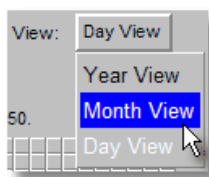

Here is an example of a month view for the camera:

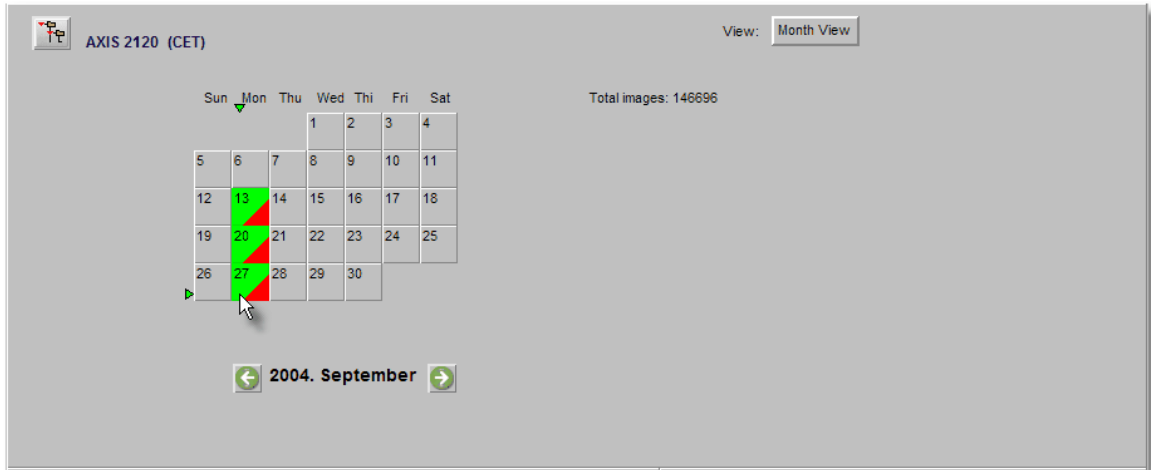

3. With the mouse select the time span of the archive that you want to play back. To do this press the left mouse button at the start of the time range, then move the mouse pointer to the end of the time range and then release the mouse button. The color of the selected time range changes to dark green.

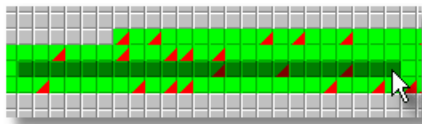

4. Also select the playback acceleration by moving the **Playback acceleration** slider (default value is 1). At the slider you can see in parentheses how long the selected time will need for playback at the selected playback acceleration.
5. Now click the **Playback** button . This brings you to the **Player** view and the images for the selected time span are loaded from the server and then will be replayed with the specified acceleration (you can cancel the loading process by pushing the **Cancel** button).



In the **Playback view** you have several possibilities:

- Automatic or manual fast forward and rewind of recordings
- Selection and playback of a time frame (time zooming)
- Synchronous playback of recordings of up to 4 cameras
- Export of individual images as well as the selected video sequence

6.2.2 Moving forward and back in the recording

Automatic playback: By clicking the **Playback** buttons  or  you can let the recording automatically play forward or back. With the **Playback Speed** slider at the left of the window you can vary the playback speed. Press the **Stop** button  to end playback.

Manual playback: By clicking and moving the green Playback marker , you can control the playback of images manually.

You can select the size of the playback by clicking the **Original size** button at the lower left of the **Player** dialog. Here you have the possibility to choose from various sizes.

6.2.3 Zooming in a view port and in archive recordings

VisoGuard allows you to zoom view ports in the Online monitor and in the Archive player.

Basically, you have two ways to zoom a view port or a recording in the Archive player:

Zooming with the mouse wheel

1. Just move the mouse pointer over a view port and turn the mouse wheel. The view port will zoom accordingly.

2. You can move the zoomed area in a view port by dragging it with the mouse.
3. Use the mouse wheel again to zoom out.

Zooming by drawing a zoom rectangle

1. With the mouse draw a rectangle in a view port.
2. Click in this rectangle, which will cause the view port to zoom accordingly.
3. You can position the zoom by dragging the rectangle. You can also modify its size by turning the mouse wheel.
4. Click outside the rectangle to return to normal (not zoomed) view.
5. You can remove the zoom rectangle by clicking into it with the mouse and pressing the **Delete** or **Backspace** key. Alternatively, you can drag the rectangle outside of the view port to remove it.

You can also have multiple zooming rectangles per view port.





Showing a zoomed view in another view port (Online monitor only)

1. Draw a zoom rectangle with the mouse.
2. Click into another view port. Now the zoomed area is shown in the other view port.
3. You can position the zoom by dragging the rectangle.
4. You can remove the zoom by clicking the rectangle with the mouse and pressing the **Delete** or **Backspace** key. Alternatively, you can drag the rectangle outside of the view port to remove it. Removing a rectangle will also remove the zoomed view from the other view port.

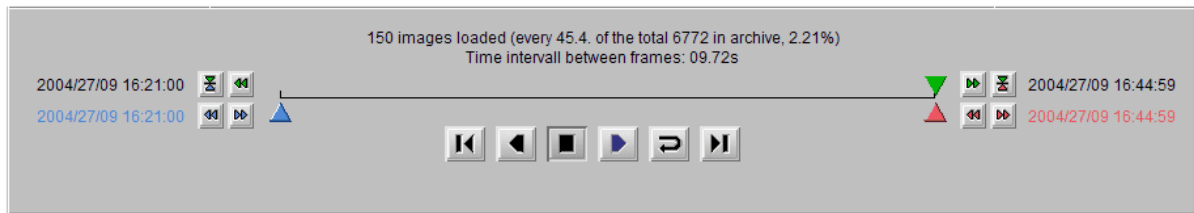
Please note: When PTZ control is enabled, any mouse actions are taken for PTZ control. In order to control the view port zooming, hold down the **CTRL** key while using the mouse.

6.2.4 Playback of a time frame (time zooming)



1. The red and blue markers   let you select a smaller time interval for detailed playback. Alternatively, you can click the **Set Blue Marker** button  or **Set Red Marker** button  to set the respective marker at the current position of the green Playback marker.
2. Click the **Zoom in** button  to load and replay the time interval between the blue and red markers.

6.2.5 Playback with audio

If the recording also includes audio (i.e. the recording has been done with MPEG-4 or H.264 and with Audio recording enabled), then you can decide whether you also want to replay audio. By default Audio is switched on, when you replay. To toggle audio on or off, push the  button in the Playback view.

6.2.6 Synchronous playback of up to four recordings

1. Select the playback time frame for the first camera as described above. Then change to the **Player** view.

2. Click the **Synchronous Playback** button , which opens the **Camera tree**, where you can select the second camera for synchronous playback.
3. Repeat camera selection until you have up to 4 cameras for synchronous playback.

The following illustration shows synchronous playback of two cameras:

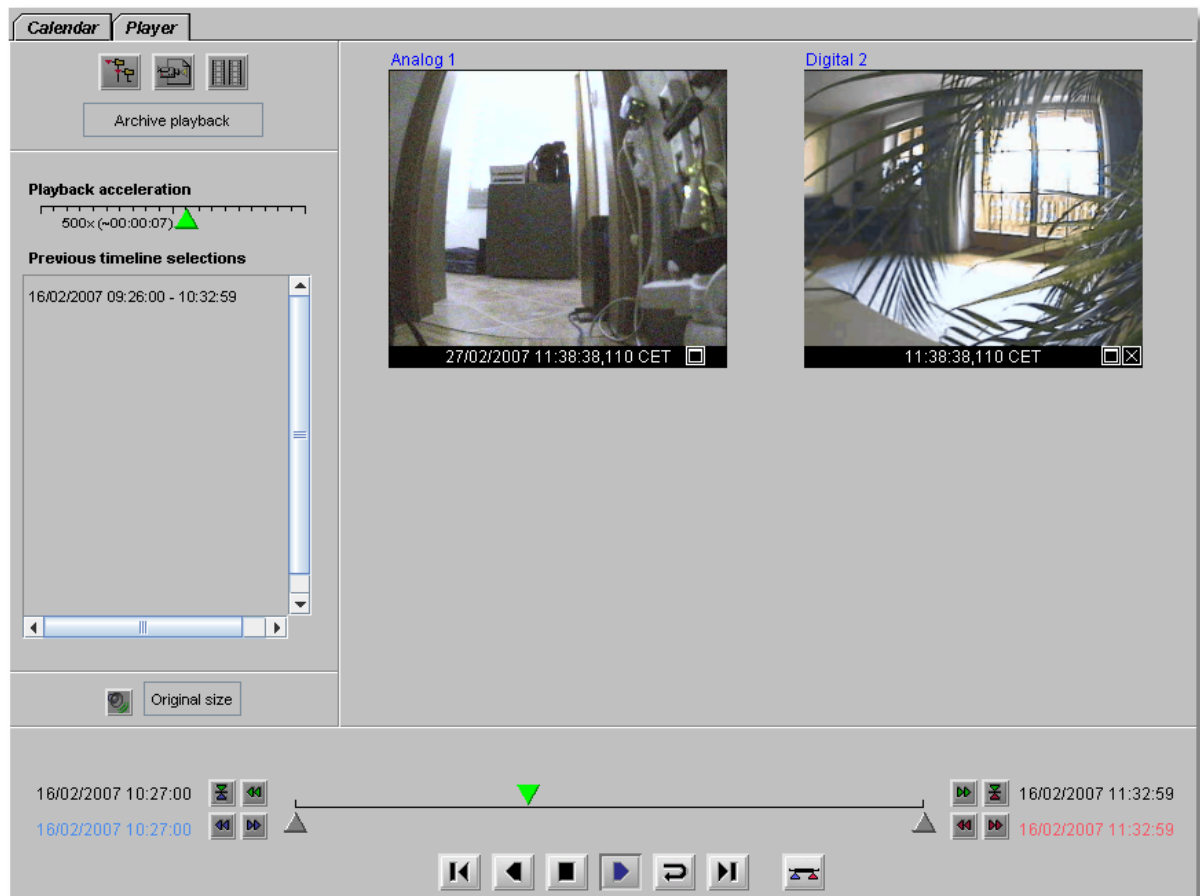

6.2.7 Displaying video analysis (iCAT) information for recordings

The **iCAT** submenu in the **Control menu** offers various options for displaying iCAT-related video analysis information also for recordings. Please refer to *14.4 Working with iCAT* on page 117 for further information.

6.2.8 Protection of recordings against automatic deletion

Normally VisoGuard automatically deletes recordings that are older than the **Requested recording period** in order to free space for new recordings. For cases where you want to keep certain scenes longer than the requested recording period you can protect arbitrary periods against automatic deletion. Here is how you can do that:

1. In the **Archive** go to the **Calendar** view and select a camera.
2. In the calendar select the period you want to protect against automatic deletion.
3. Press **Protect selected images against deletion**.
Now the color of the selected period in calendar turns to a different color which shows that the images are protected.

To unprotect a protected period you must select this period in the **Calendar** view and Press **Unprotect selected images**.

Caution: Please be careful when using this feature since the protected recording periods will never be deleted automatically by VisoGuard. This means that the space will be locked as long as you keep them protected.

6.3 Exporting recordings (images and video sequences)

VisoGuard allows you to export individual images and video sequences in various formats:

- **JPEG:** for single images
- **AVI DivX:** for video sequences
- **SAFE:** This is a proprietary format that stores the video together with the player in an executable format (.exe) that can be run on MS Windows platforms. The file can be password protected and you can export synchronous video sequences of up to 16 cameras simultaneously.

The following sections describe how you can export from the recording archive. In *8.2.2 Exporting event-related recordings* on page 66 you learn how to export recorded video sequences based on events.

6.3.1 Exporting a single JPEG image (the current frame)



1. In the **Archive**, select a camera for the export.
2. In the **Calendar** select the time for exporting the image.
3. In the **Player** move to the picture you want to export and click the **Export** button  to open the **Export** dialog.
4. Choose **Current image (JPEG)** from **Export format**.
5. Enter a file name for the image to be saved.
6. Mark the first checkbox if you want to overwrite a file of the same name that might exist.
7. When you click **OK** a file dialog will be opened asking where on your client computer you want to save the file. Select the location and confirm.
8. Now you can use the exported file.

6.3.2 Exporting a recording in AVI DivX format

1. In the **Archive player**, select a camera for the export.
2. In the **Calendar** select the time period for exporting .
3. In the **Player** view or in the **Calendar** view click the **Export** button  to open the **Export** dialog.
4. You have two **AVI** options for **Export format**:
 - **AVI (all images):** This exports a video sequence with all the frames of the currently selected time frame (regardless of the **Playback acceleration** setting).
 - **AVI (Subsampled movie):** This exports the time-lapse playback with the settings of the **Playback acceleration** slider. E.g. if you have selected a **Playback acceleration** of 3, your exported file will be roughly a third of the size of an **AVI (all images)** export. See also *6.2.1 Selecting the camera and the playback period* on page 48.
5. Enter the file name of video to be exported.
6. Mark the first checkbox if you want to overwrite a file of the same name that might exist.
7. When you click **OK**, a file dialog will be opened asking where on your client computer you want to save the file. Once you select the location and confirm, a **File download progress dialog** will show the state of the export. You can cancel the export anytime by pushing **Cancel**.

Note: To play back exported video sequences with Microsoft Media Player, you need the DivX codec. You can download this for free from www.divx.com/divx.

6.3.3 Exporting a recording in SAFE format

1. In the **Archive**, select a camera for the export.
2. In the **Calendar** select the time period for exporting .
3. In the **Player** view or in the **Calendar** view click the **Export** button  to open the **Export** dialog.
4. Choose **SAFE (All images)** from **Export format**.
5. Enter the file for the video sequence to be exported.
Mark the first checkbox if you want to overwrite a file of the same name that might exist.
6. Optionally you can create a **Multi-camera export** (synchronous video sequences) by clicking on the **Select camera** button . This opens the camera tree in which you can select multiple cameras by holding the **CTRL** key while clicking on the cameras.
7. Enter an **Export file label** which should describe the exported scenes.
8. Optionally you may enter an **Export file password**. This password is asked when the export file is executed (played).

Caution: Do not forget this password because otherwise you cannot replay this exported file.

9. When you click **OK**, a file dialog will be opened asking where on your client computer you to want to save the file. Once you select the location and confirm, a **File download progress dialog** will show the state of the export. You can cancel the export anytime by pushing **Cancel**.
10. The exported file is an executable for MS Windows 7/Vista/XP.
Here is a screen dump of a running SAFE file:

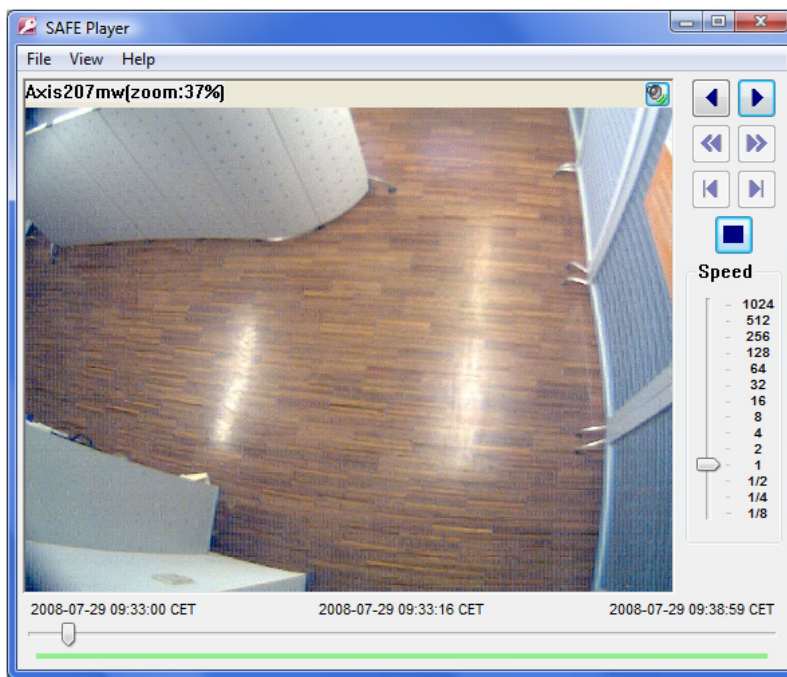

Zooming in exported SAFE video sequences

You can zoom into parts of the camera view by drawing a rectangle and then clicking in the rectangle. You can drag a zoomed view with the mouse. Alternatively you can show the zoomed view in a separate window by selecting **View > Separate zoom window**. You can also use the mouse wheel to zoom in and out. See also 6.2.3 *Zooming in a view port and in archive recordings* on page 51.

6.4 Motion detection in archive recordings

VisoGuard supports server-based motion detection not only for live camera streams but also in the archived recordings. Here you find information about how to execute motion detection on recordings.

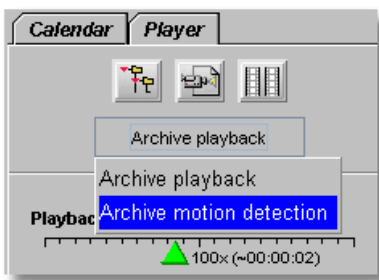

Please note: In this version, VisoGuard supports archive motion detection only for MJPEG recordings and not for recordings of other streaming formats (like MPEG-4 or H.264).

1. Go to the main window and choose the **Archive player** (if the Archive player is not available, then perhaps it is disabled in the client preferences; see 2.4 *Client multi-window and multi-screen operation* on page 17).
2. In the **Calendar** view of the Player select the camera and the timeframe for the motion detection.
3. Push on the **Playback** button . This will load the images of the timeframe and replay the recorded images.
4. In the Upper left corner of the **Player** view select **Archive motion detection** from the **Control menu**:

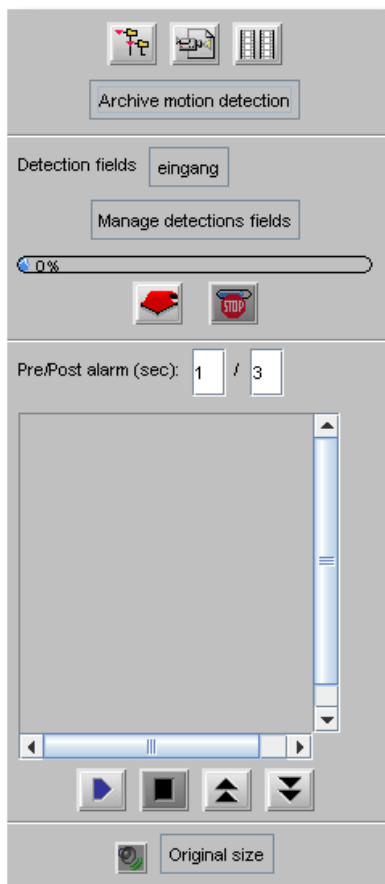

Now the motion detection pane is opened on the left side in the **Player** view:





- From the **Detection field** pop-up menu choose the motion detection field definition you want to use for this motion detection. If you do not yet have a detection field defined or want to change an existing definition, then you can push the **Manage detection fields** button to jump to the Detection fields view in Administration. Please refer to *7.1.2 Basic configuration of server-based motion detection* on page 58 for details on how to setup detection fields. Continuing here, we assume you have a correctly set up detection field definition.
- To start the server-based motion detection Push the **Start** button . You can see the progress of the motion detection at the progress bar. You can always stop a running motion detection by pushing the **Stop** button .

Caution: Since the motion detection actually runs on the VisoGuard server and can potentially use up a lot of CPU resources, please be careful selecting the detection fields and also the time period. Especially if you have selected a long time period in the Calendar the motion detection can take a lot of time. As mentioned above, you can always stop a running archive motion detection.

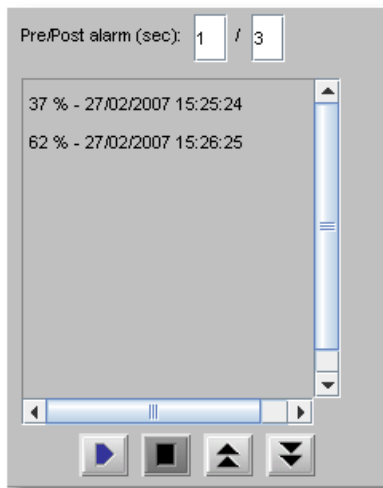
- While the motion detection is running, the detected motions are displayed in the hit list sorted by the time in which the motion occurred. In our example, we have 2 hits:



- You can replay the events by just selecting the event with the mouse. The playback time before and after the event can be defined by the **Pre/Post event (sec)** fields. You can change the values according to your needs. Please note that there must be archived pre- and post-event recordings available in order to be replayed.
- You can step through the events by pushing the **Previous**  and **Next**  buttons.

7 Working with simple motion detection

Please note: Since release R1.12 VisoGuard offers powerful video analysis functions with iCAT. This chapter describes the simple motion detection features that were present before R1.12 and that are now a part of the iCAT toolbox. Simple motion detection is based on a detection of changed pixels between video frames while iCAT offers intelligent object detection and tracking. For more details on iCAT refer to *14 Video analytics with iCAT* on page 100.

VisoGuard offers two mechanisms for simple motion detection:

- **VisoGuard's own server-based motion detection:** The images are analyzed by the VisoGuard server. The advantage of this method is that it works with any camera, even old cameras. The disadvantage might be that if there are many cameras that transfer their images to the server for analysis, the bandwidth of the network could be burdened and also the server could be overloaded.
- **In-camera motion detection:** The images are analyzed in the camera and only when detection occurs, an event and image data are sent to the VisoGuard server that then stores the event and the images in its archive. The advantage of this method is that the network and the server are not burdened. The disadvantage is that it works only with special cameras, that offer this feature and that the motion detection settings have to be programmed in the camera directly.

7.1 VisoGuard's own server-based motion detection

The simple motion detection feature of VisoGuard can recognize motion by detecting pixel changes between video frames. Such a detection can then trigger the following predefined actions:

- Entry of events in an Event list (optionally accompanied by an acoustic signal).
- Changes in recording behavior (e.g. higher recording rate) if that has been programmed (see *6 Working with archive recordings* on page 45).

Here you find the steps how to configure the parameters for simple motion detection.

7.1.1 Preparation

Before you begin to configure a motion detection definition, be sure that you have the necessary authorization to make settings. If you are not sure, please ask your VisoGuard administrator.

Please note: Motion detection for PTZ cameras is problematic since normal movement of the camera will trigger a motion detection event.

7.1.2 Basic configuration of server-based motion detection

If you are not already running the VisoGuard client application, open your Internet Explorer and log in to your VisoGuard server and your VisoGuard system.

1. Choose **Video analysis (iCAT)** from the **System administration** menu. This opens the **Video analysis (iCAT)** dialog.

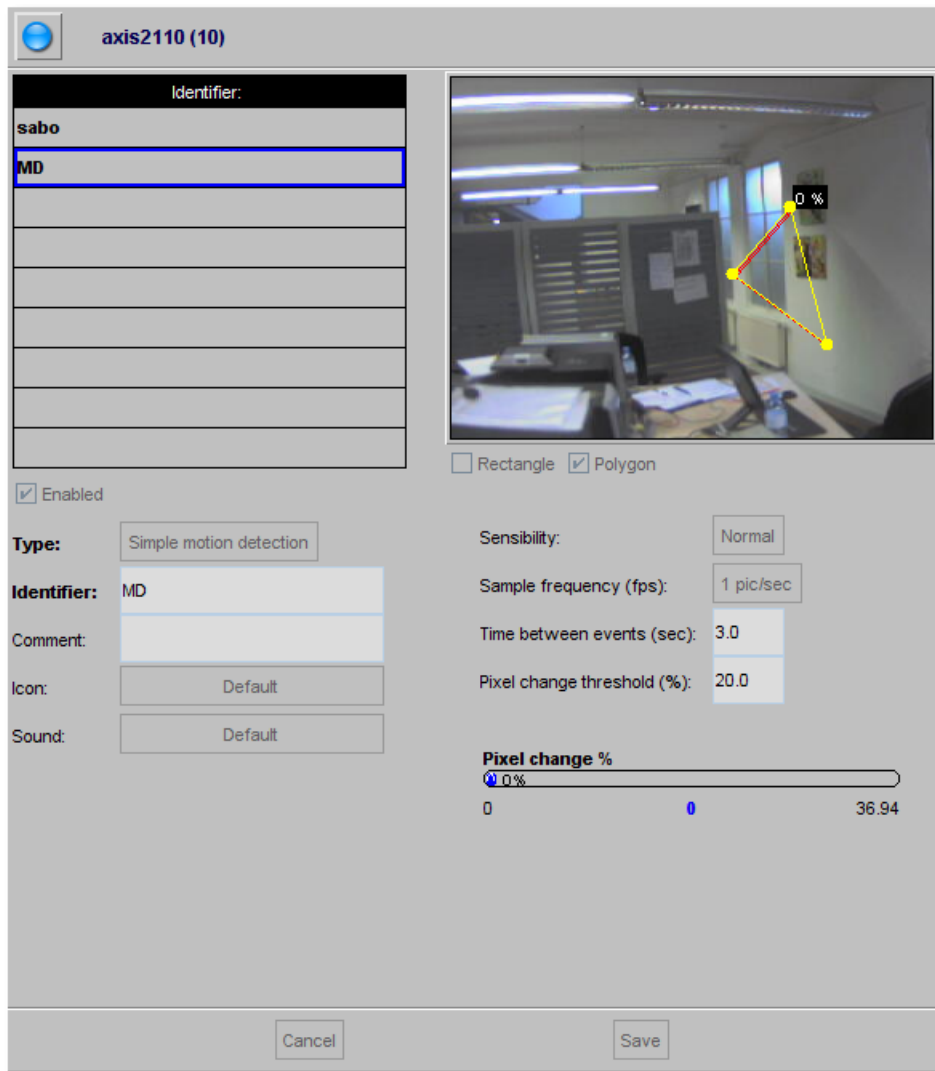

2. In the camera tree at the left, select the camera for which you want to create a motion detection definition.
3. In the menu choose **Add new definition**.
4. From the **Type** menu chose **Simple motion detection**.
5. Select whether you want to create a **Rectangle** or a **Polygon**.
6. Use the mouse to draw a detection field in the preview area.
7. Mark the **Enabled** checkbox, otherwise the detection field is inactive and no detection can occur. Actually, a detection field must also be assigned to an active motion detection schedule (see below).
8. Assign a name for the field in the **Identifier** text box, e.g. "Movement".
9. Optionally, you can enter a **Comment**.
10. Usually the **Sensitivity** should be left at **Normal**. It defines how sensitive (or tolerant) the detection algorithm is when detecting the change of pixels. Modify the setting only when you want the algorithm to be more or less sensitive.
11. In the **Sample frequency (fps)** field you can specify how often the image is to be checked for changes.
12. In the **Time between events (sec)** field you can enter the minimum time that must elapse before a following event is triggered. This helps to filter out repetitive events. Minimum time (sec) = 3 means that, after one motion detection event has been triggered, at least 3 seconds must pass before another Motion Detection event can be generated.

13. In the **Pixel change threshold (%)** field you can define how many pixels in % must change so that a detection event is triggered.
Pixel change (%) = 20 means that 20% of the pixels relative to the previous frame (detection cycle) must change for a detection to be triggered.
14. Optionally you can define a specific event icon and sound for this definition: Click on the **Icon** button to assign a symbol. This icon is displayed in the **Event list** to notify an operator when an event related to this definition occurs.

Click on the **Sound** button to assign a specific sound to the definition. This sound is played when a user notification event related to the definition occurs.

15. After you have entered all parameters for your definition, save it by clicking on the **Save** button.
16. If you have not yet scheduled a detection-based recording for this camera, you will be prompted for whether you want to edit the scheduling now.

Click on the **Yes** button if you want to configure the scheduling now. Please refer to section 7.1.3 *Scheduling motion detection* on page 60.

Click **No** if you want to do that later.

Please note:

If you add a new iCAT definition, it will automatically be assigned to all iCAT schedules of the camera. If you do not want that, you have to remove the assignment manually.

If a definition is not assigned to an active schedule then it will not be activated (no archive recordings will be made and no events will be generated) although it has the **Active** option set.

7.1.3 Scheduling motion detection

The scheduling for simple motion detection is the same as for other iCAT definitions. Please refer to 14.3.9 *Scheduling iCAT operation and recording* on page 115.

7.1.4 Controlling PTZ cameras with motion detection events

It is possible to assign a sequence of PTZ positioning actions to each motion detection (MD) field definition. Once the MD field gets active, the associated PTZ action is executed. PTZ actions can be assigned to an MD field by appending the following sequence to the MD **Identifier**:

ptz:<CID>:<PresetName>:<WaitTime>:<PresetName>:<WaitTime>...

where:

<CID> is the ID of a PTZ camera (the ID is shown in **Camera admin > Properties** dialog next to the camera name). If **<CID>** is 0, then the MD field's camera is controlled (MD and PTZ camera are the same).

<PresetName> is the name of a preset position (as entered in the PTZ definitions).

<WaitTime> is the pause time in seconds starting from the time when the camera receives the positioning event.

There can be any number of "**<PresetName>:<WaitTime>**" pairs added.

Further MD-triggered PTZ actions are blocked as long as a sequence is running. However, control of PTZ camera can be taken manually, then the automatic MD-triggered PTZ control is suspended until the manual PTZ control is released.

For information on how to setup PTZ preset positions refer to 9 *Working with PTZ cameras* on page 69.

Example of an motion detection Identifier:

Door ptz:4:Door:10:HomePos:3

will on an MD event with the **Identifier** "Door" move the PTZ camera with ID 4 to the preset position "Door", wait 10 seconds and move the camera to the preset "HomePos" and wait another 3 seconds. The overall positioning time therefore is app. 13 seconds. From then on the PTZ camera is open to receive further MD-triggered PTZ positioning commands.

7.2 Motion detection in archive recordings

VisoGuard supports server-based motion detection not only in live streams but also in archived recordings. Please refer to *6.4 Motion detection in archive recordings* on page 56.

7.3 In-camera motion detection

Several IP cameras and video servers support in-camera motion detection and upload (push) of event-triggered images via FTP or HTTP to a video management system like VisoGuard. VisoGuard implements a general mechanism to handle this feature.

This section describes how VisoGuard supports in-camera motion detection and also how to configure it in VisoGuard.

Please note: Since the camera carries out the detection, the actual configuration and programming must be done directly in the camera via the setup interface (e.g. parameters like detection settings, image quality, speed, etc.). This can usually be done by connecting with a web browser to the camera (by entering its IP address). Please refer to the most actual document *Thecus VisoGuard 4.3 Supported Video Sources* and the camera's user manual for further details.

7.3.1 How VisoGuard supports in-camera motion detection

In the camera you define the various settings for the motion detection algorithm and for the transmission of event images to the VisoGuard server, which is done via FTP or HTTP ("push upload" by the camera). Most cameras also support the transmission of pre- and post-event images. The configuration of for these pre- and post-event images must also be done in the camera.

VisoGuard is capable of doing these things in connection with in-camera motion detection:

- **Receive in-camera motion detection events** from the camera and store these events in the standard VisoGuard Event database (these events can also be displayed in the Event list).
- **Receive pre- and/or post-event images** from the camera (pushed by the camera) and record these images in the standard VisoGuard camera archive.
- Optionally, with receiving an in-camera detection event, **start a server-based post-event recording** of images and merging this recording with the in-camera event images pushed by the camera. This server-based recording can have a much higher frame rate than the pictures pushed by the camera. This allows a much better documentation of in-camera events.

7.3.2 Setting up in-camera motion detection

To configure VisoGuard for in-camera motion detection follow these steps:

1. Choose **Camera admin** from the **System administration** menu. This opens the **Camera admin** dialog.

Assuming that you have already defined the basic properties of the camera in VisoGuard, select the camera in the camera tree.

2. On the **Properties** dialog push the **Next** button at the bottom of the dialog until you reach the **Defaults settings** dialog. Here you focus on the **In-camera motion detection** settings:

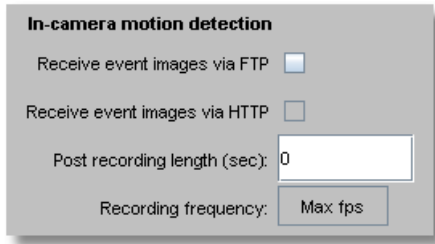

3. In the menu choose **Modify selected camera or group**.
4. Mark either **Receive event images via FTP or ...via HTTP** depending on what your camera supports. This tells VisoGuard to receive in-camera events and images from the camera. If you already have a defined an active server motion detection schedule for the camera, you will get a dialog that tells you that having both, server and in-camera motion detection at the same time is not possible. To continue you have to first disable the server-based motion detection schedules in the **Scheduling** dialog and then you can continue here.
5. Optionally you can set the **Post recording length (sec)** that defines whether and for how long the VisoGuard server should record camera images in addition to receiving and storing the event pictures pushed by the camera. As mentioned above, you could want to do that to record the post-event images with a high frame rate. In such a case, set the **Frame rate** according to your needs.
6. Now you also have to tell VisoGuard, for how long it should keep the recorded event-images (both, the ones pushed by the camera and the ones, additionally recorded by the server). Push **Previous** button at the bottom of the dialog until you reach the **Scheduling** dialog.
7. Below the **Time intervals** list push the **Add** button and then choose **Camera MD (FTP/HTTP)** from the newly created **Change** pop-up menu.
8. In the field **Requested recording period (days/hours)** enter the values that fits your needs. Optionally you can also mark the **Priority over other cameras (if storage space is short)** checkbox. For further details about these recording parameters please refer to sections *6.1.1 Programming continuous timed recordings* on page 45 and *6.1.3 Operation of the VisoGuard dynamic storage management* on page 47.
9. Push the **Save** button to store your changes.
10. Now you have to configure your camera for pushing the in-camera events and images to the VisoGuard server. Since the steps for doing that are very camera-specific, you must consult the document *Thecus VisoGuard 4.3 Supported Video Sources*. To program the camera's detection algorithm please consults its user manual.

Note: After setting up the camera, do not forget to check and set the date and time of the camera to reflect your current time.

8 Handling events

VisoGuard can record and display events of various types. They can be camera-related events like video analytics events, archive access by a user, or camera failures, but also system-related events like user logon and logoff.

Events are displayed in Event lists of the client and are stored in the central event database of the server where they can also be queried. They have several properties that depend on the type of the event.

Event priorities

All events also have an event priority that defines the relative importance of events. The default event priority is 100. Informational events have a lower priority of 50, system and camera malfunction events have a higher priority of 300. For events generated by video analytics triggers, you can specify individual event priorities. Event lists can also be sorted according to priority.

User privileges for accessing and handling events

In the **User admin** under the **System administration** menu you can define for each user some basic event handling privileges. For example whether user you can access events at all or what kinds of system events are displayed at the users event list (see *4.2 Setting general user privileges* on page 31).

The number of events stored in the database can be defined in the server parameters (see *10.2 Setting VisoGuard server parameters* on page 78).

8.1 Event list and event details

The most actual events are displayed in the **Event list**:

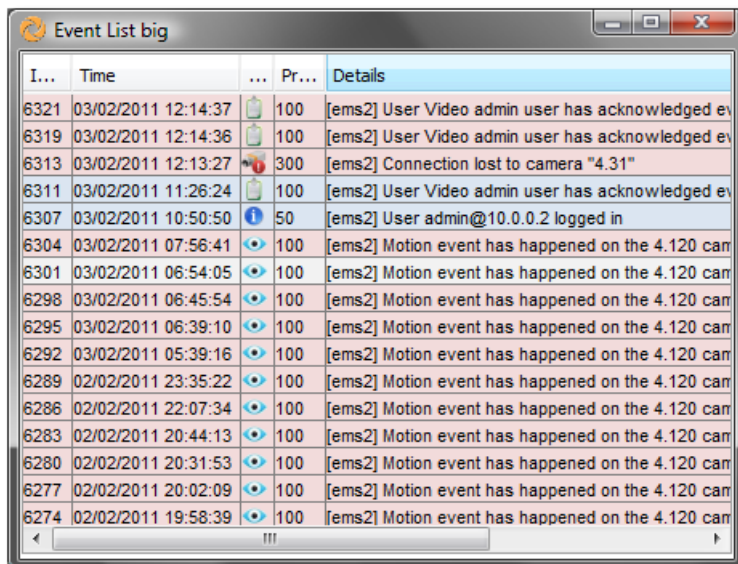

I...	Time	...	Pr...	Details
6321	03/02/2011 12:14:37		100	[ems2] User Video admin user has acknowledged ev
6319	03/02/2011 12:14:36		100	[ems2] User Video admin user has acknowledged ev
6313	03/02/2011 12:13:27		300	[ems2] Connection lost to camera "4.31"
6311	03/02/2011 11:26:24		100	[ems2] User Video admin user has acknowledged ev
6307	03/02/2011 10:50:50		50	[ems2] User admin@10.0.0.2 logged in
6304	03/02/2011 07:56:41		100	[ems2] Motion event has happened on the 4.120 cam
6301	03/02/2011 06:54:05		100	[ems2] Motion event has happened on the 4.120 cam
6298	03/02/2011 06:45:54		100	[ems2] Motion event has happened on the 4.120 cam
6295	03/02/2011 06:39:10		100	[ems2] Motion event has happened on the 4.120 cam
6292	03/02/2011 05:39:16		100	[ems2] Motion event has happened on the 4.120 cam
6289	02/02/2011 23:35:22		100	[ems2] Motion event has happened on the 4.120 cam
6286	02/02/2011 22:07:34		100	[ems2] Motion event has happened on the 4.120 cam
6283	02/02/2011 20:44:13		100	[ems2] Motion event has happened on the 4.120 cam
6280	02/02/2011 20:31:53		100	[ems2] Motion event has happened on the 4.120 cam
6277	02/02/2011 20:02:09		100	[ems2] Motion event has happened on the 4.120 cam
6274	02/02/2011 19:58:39		100	[ems2] Motion event has happened on the 4.120 cam

Each client can have multiple event lists, for example, one that is sorted chronologically and another one that is sorted according to event priorities. In the client preferences (accessible via **Client preferences...** in the **VisoGuard** menu) you can define for each event list what columns are to be displayed and whether acknowledged events should stay in the list or should disappear automatically (which is the default behavior).

The position of the event lists inside client windows and further layout options can be defined as described in *2.4 Client multi-window and multi-screen operation* on page 17.

You can sort the event list according to column values by just clicking on the column title. Little arrows after the title indicate the sorting order (ascending or descending). Clicking a column title again will change the sorting order. For example, you can sort the list according to event priority by clicking on the **Priority** column heading.

In an event list columns can be rearranged by clicking on a column title and dragging it with the mouse to the new location.

Unseen events have a light red background color. As soon as an event has been opened in the **Event details** dialog its background color changes to light grey. When an event is acknowledged, it usually disappears from the event list. However, in the client preferences you can define whether acknowledged events should be displayed in the event list. If so, they appear with a white background color.

8.1.1 Event details

Double clicking on an event in the event list opens the **Event details** dialog.

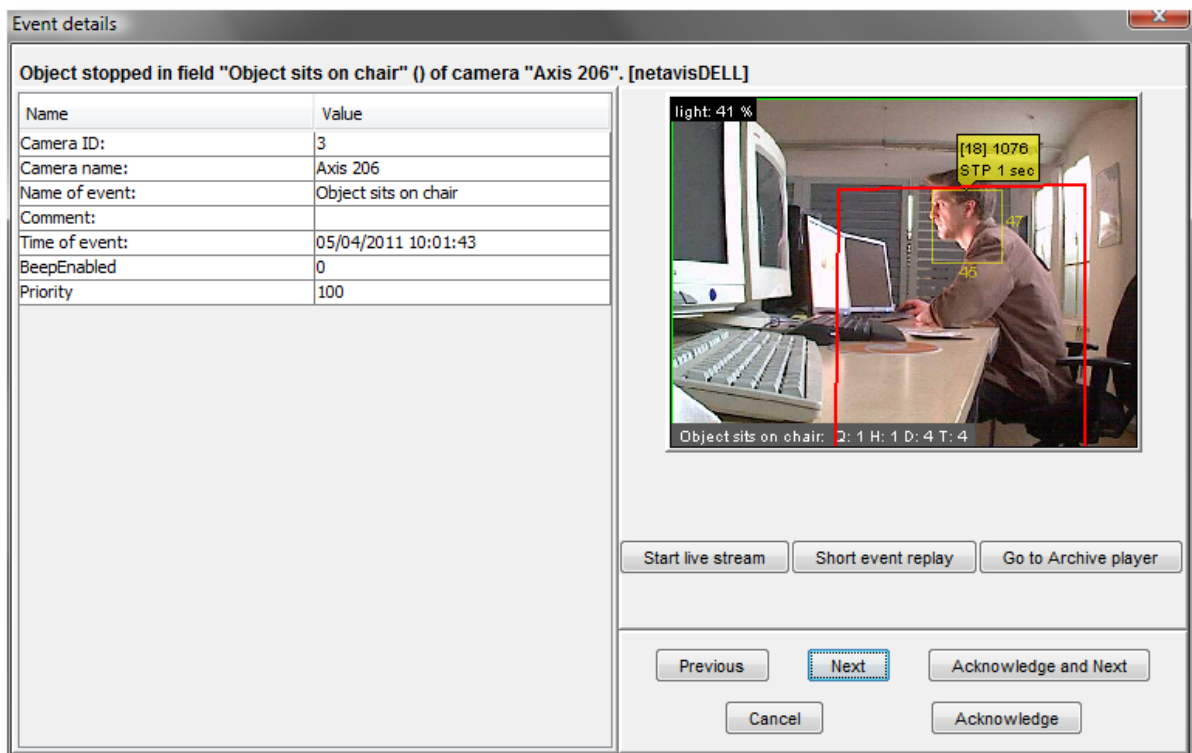

The first line contains the event text. Further details of the event are listed at the left side of the dialog. The exact contents of the event details depends on the event type, but you will at least find the exact time when the event occurred and if it is camera-related then also the camera ID and name are shown.

When you move the mouse over the camera preview area you will also see the video analytics object markers and annotations related to the event trigger (as seen in the screen shot above).

Here is what you can do in the dialog by pushing various buttons:

- **Start live stream:** starts live monitoring of the camera that triggered the event .
- **Short event replay:** starts a playback of the event recording that triggered the event (a replay is only available if the camera has been configured to record on the event).
- **Go to Archive player:** opens the Archive player and starts a playback of the event recording.

- **Previous:** loads the previous event.
- **Next:** loads the next event.
- **Acknowledge and next:** acknowledges the event and loads the next event.
- **Acknowledge:** acknowledges the event and close the dialog.
- **Cancel:** closes the dialog.

8.2 Searching in the event database

1. When you choose **Event search...** from the **Events** menu the **Event search** dialog appears.
2. Select the **Time filter** according to your needs.
3. Push **Search** to display the results.
4. You can further constrain the search by setting values for **Event type**, **Name of camera**, **Name of user**, or **Event ID (from- to)**. For some values an appropriate dialog will open, e.g. the Event selection dialog:

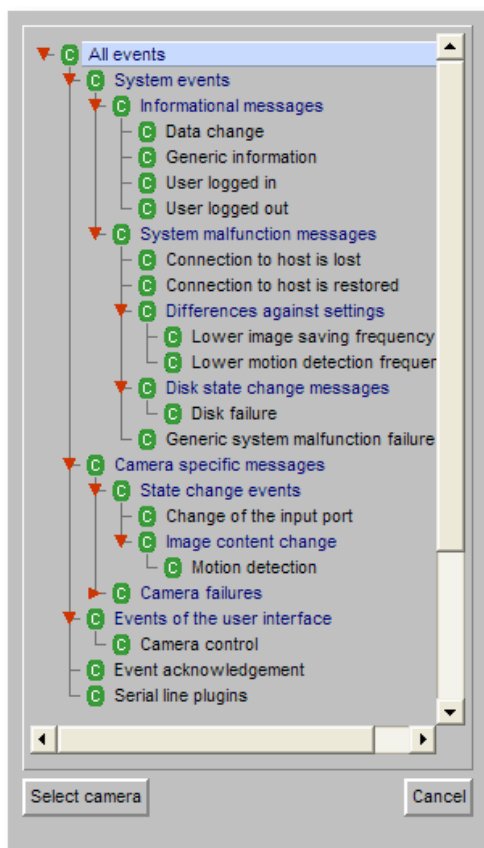

In each of the dialogs it is possible to make multiple selections. For example to search for the event types **User logged in** and **User logged out**, hold down the **CTRL** key and select these event types with left mouse clicks:

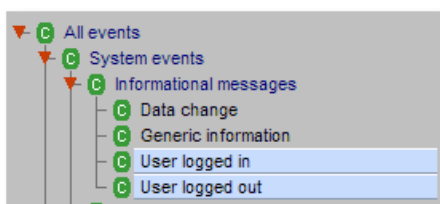

You can also search for events which are **acknowledged** or **not acknowledged** by selecting the appropriate check box.

5. After setting different search criteria push the **Search** button again to display the results.

By clicking the **Next** button you can step forward in the result list and with **Previous** button you can step back.

8.2.1 Saving results in an HTML file

You can export the search results to an HTML file:

1. In the **Event search** dialog push the **HTML export...** button, which opens an export dialog.
2. Enter a file name and choose whether you want to export only the events displayed in current search list or all events matching the filter criteria.
3. Push **Export**. Now the file is created. You can open the file in a normal web browser:

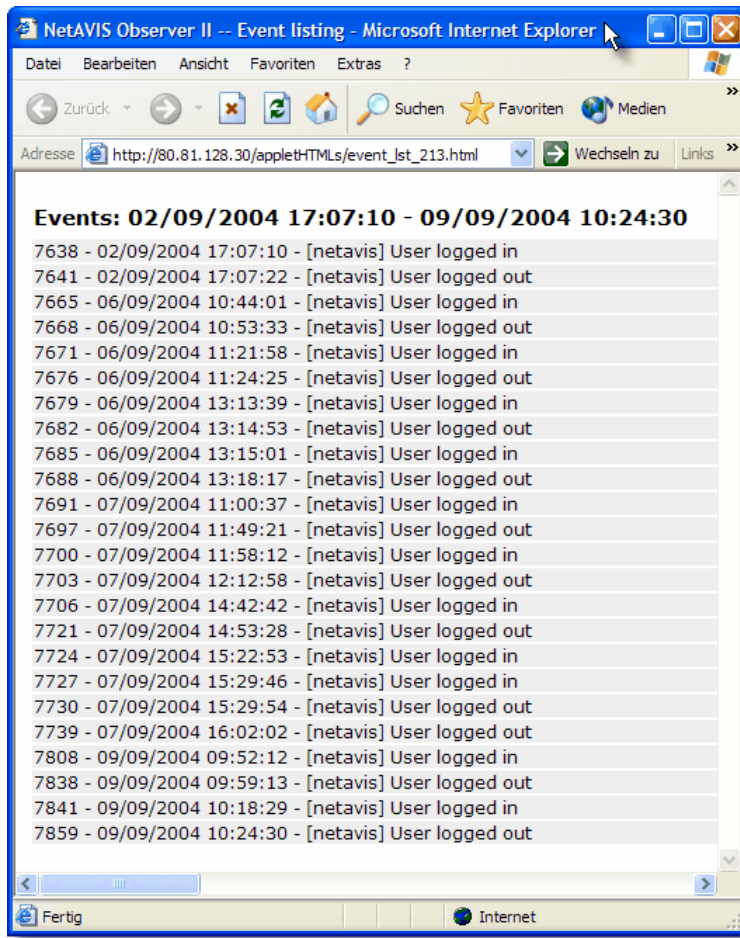

8.2.2 Exporting event-related recordings

You can export event-related video recordings from the **Event search** dialog. For each event that has recording associated a separate video file is created. The file name is composed of the event ID, date, time, and event type. The export can be done in 2 formats: AVI (DivX) and SAFE (see also 6.3 *Exporting recordings (images and video sequences)* on page 54).

Here is how you can do that:

1. In the **Event search** dialog push the **Video export...** button, which opens an export dialog.
2. Select the directory where the exported video files are to be stored and choose whether you want to export only the events displayed in current search list or all events matching the filter criteria.

You can also supply the pre- and post-event time to be exported.

Select the video format.

3. Push **Export**. Now a separate video file is created for each event that has a recording. At the end a summary dialog shows how many files have been create and what is their total size.

8.3 Generating an event statistics report

VisoGuard allows you to create an event statistics report in MS Excel XLS format.

To create a statistics report file, follow these steps:

1. Choose **Event statistics export...** from the **Events** menu. This brings up the **Event statistics export** dialog:

Time interval settings

Resolution: Day

Start time: 2007 - 02 - 01 00 : 00

Time period: 1 Month

Event filter

Event type: Summary for all

Name of camera: Summary for all

Name of user: Summary for all

Event parameter name: Please choose

Event parameter value:

% (= any string), _ (= any character)

OK Cancel Default

2. Select for which **Start time**, **Time period** and time **Resolution** you want to create the report. Also you can filter according to **Event type**, **Camera** and **User** (multiple selection by holding down the **CTRL** key while clicking is supported for all filters). If you do not select any values for Event filter, then a summary statistic report will be created.
3. Push **OK** to start creating the report file. You will be prompted for a file name where the report should be stored.
4. Open the created file in MS Excel. With the data, you can also create graphics like the following one (motion detection statistics for one day):

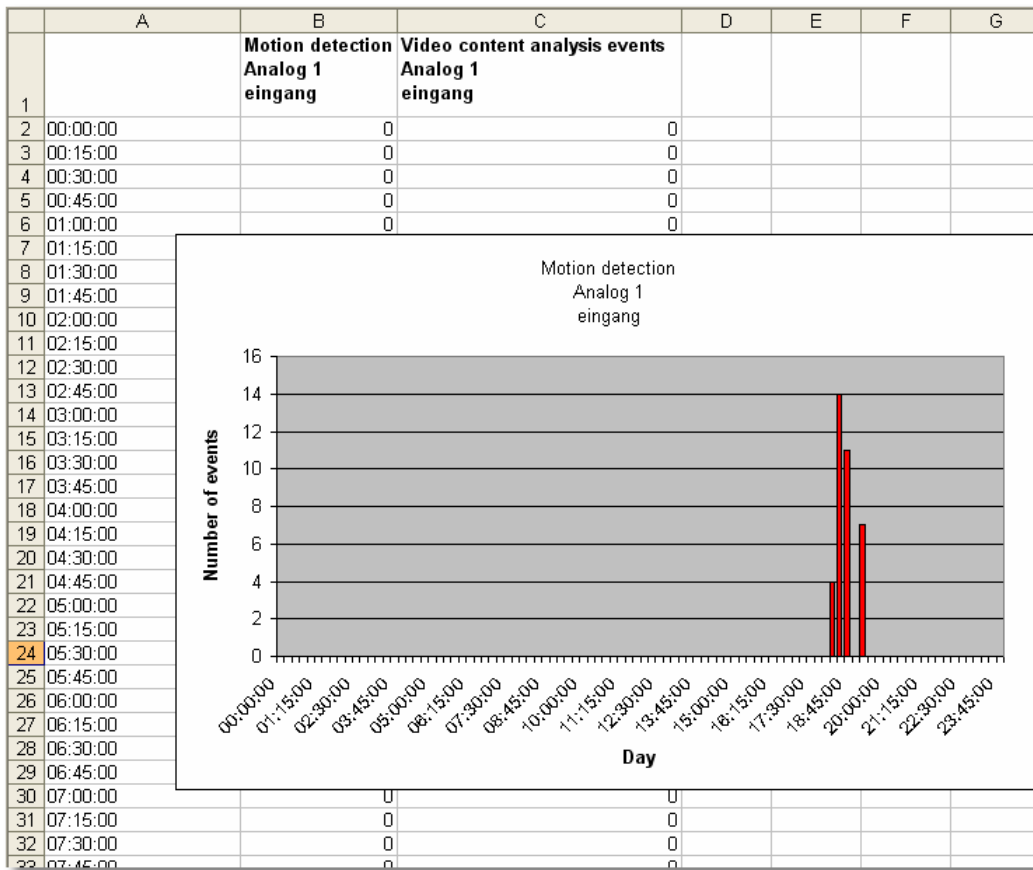

9 Working with PTZ cameras

VisoGuard features the control of PTZ cameras (pan/tilt/zoom).

Note: To configure and work with PTZ cameras, you need the corresponding user privileges and camera access rights (see *4.2 Setting general user privileges* on page 31 and *4.3 Setting camera access rights* on page 32). If you find that you do not have the authorizations you need, please contact your VisoGuard administrator.

9.1 Setting up a PTZ camera

Setting up a PTZ camera is the same procedure as setting up a camera without PTZ functionality (*3 Setting up cameras* on page 21).

The user must possess the user-specific camera authorizations (see *4.3 Setting camera access rights* on page 32) to permit PTZ access.

9.2 Defining fixed PTZ positions

1. Choose **PTZ** from the **System administration** menu. This opens the **PTZ** dialog.
2. From the camera tree, select the PTZ camera whose PTZ positions you want to program.
3. In the menu select **Add new definition**.
4. In the **Name** field enter a designation for the position and then use the **PTZ control elements** to move to the desired position (detailed explanation of control elements in *Section 9.4 Controlling PTZ cameras* on page 70):
5. Click on **Save** to save your configuration. Then you can repeat steps 3 to 5 to define additional PTZ positions.
6. From the **Online Monitor** you can select these predefined positions (see below).
7. Double-clicking on one of the predefined positions lets you position the camera. Proceed similarly in order to change positions.

9.3 Defining PTZ routes

In addition to individual PTZ positions, you can also define position routes that can be followed on command. A position route consists of a list of PTZ positions that are automatically, sequentially followed and a duration per position.

Define a PTZ route as follows:

1. Choose **PTZ** from the **System administration** menu. This opens the **PTZ** dialog.
2. From the camera tree, select the PTZ camera whose PTZ route you want to program.
3. If you have not already defined PTZ positions that now appear in the list, or you can create new positions now. See the previous section for defining new positions.
4. Click on the **Next** button at the bottom right. This takes you to the **Routes** dialog, whose layout resembles the **Positions** dialog above.
5. In the menu select **Add new definition**.
6. In the **Name** field enter a designation for the route. Optionally you can enter a description.
7. Click on **Next** to move to the **Route details** dialog:

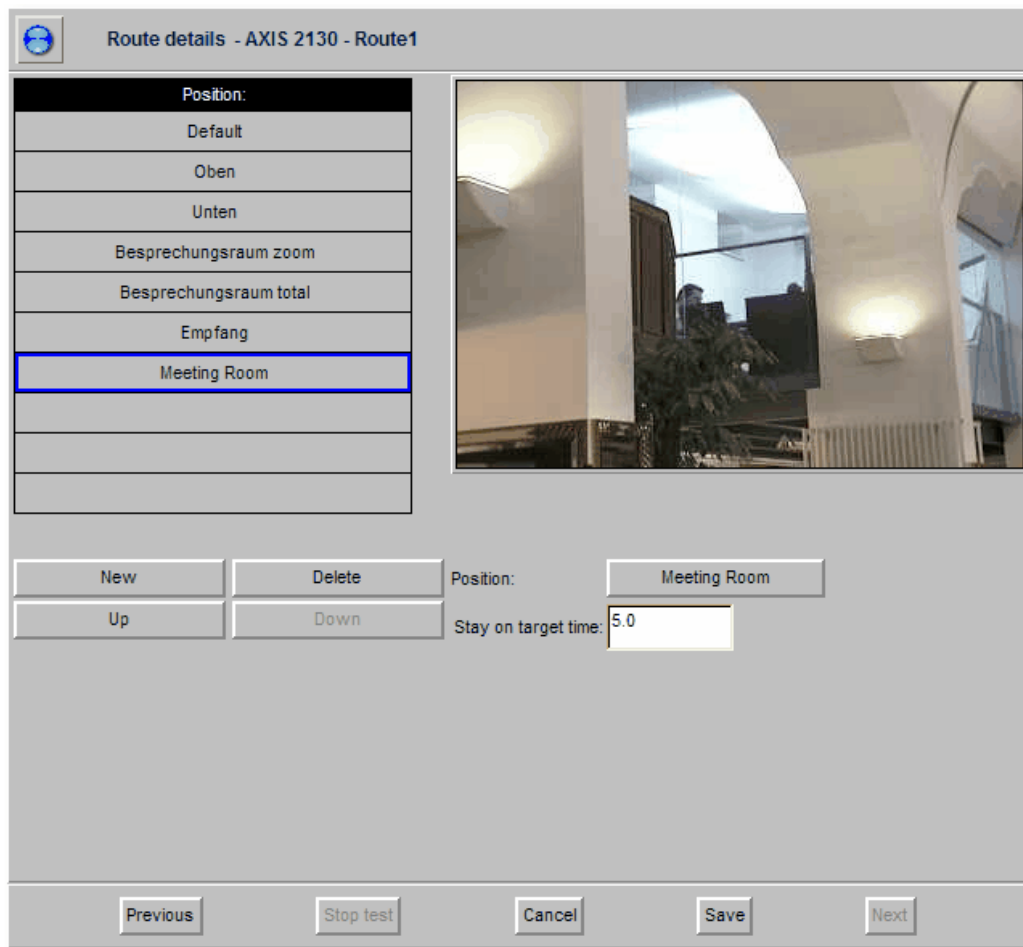



8. Click the **New** button to create a new entry in the **Position** list of the route and select a position from the list of predefined positions via the **Position** popup menu.
9. In the **Time at position** field, enter the duration in seconds that the camera is to spend at the position. Note that this time includes the positioning time of the camera.
10. Repeat Steps 8 and 9 for each entry in the position list.
11. You can change the sequence within the position list by selecting a position and then clicking the **Up** or **Down** button. You can remove an entry from the **Positions** list by selecting it and then pressing the **Delete** button.
12. Click the **Save** button to save your route or **Cancel** to discard changes.

You can select the saved route in the Online Monitor via the **PTZ** menu of the view port control menu of the PTZ camera. Proceed similarly to modify a route.

9.4 Controlling PTZ cameras

9.4.1 Controlling PTZ cameras in the Online monitor

Control PTZ cameras as follows:

1. Select the **Online monitor**.
2. Switch to a view that contains a PTZ camera (how to create views and assign cameras is covered in section 5 *Using the Online monitor* on page 35).
3. In the view port of the PTZ camera push the PTZ start button  or choose **PTZ->Activate PTZ** from the view port control menu. The icon  of the view port indicates that you have PTZ control over the camera.

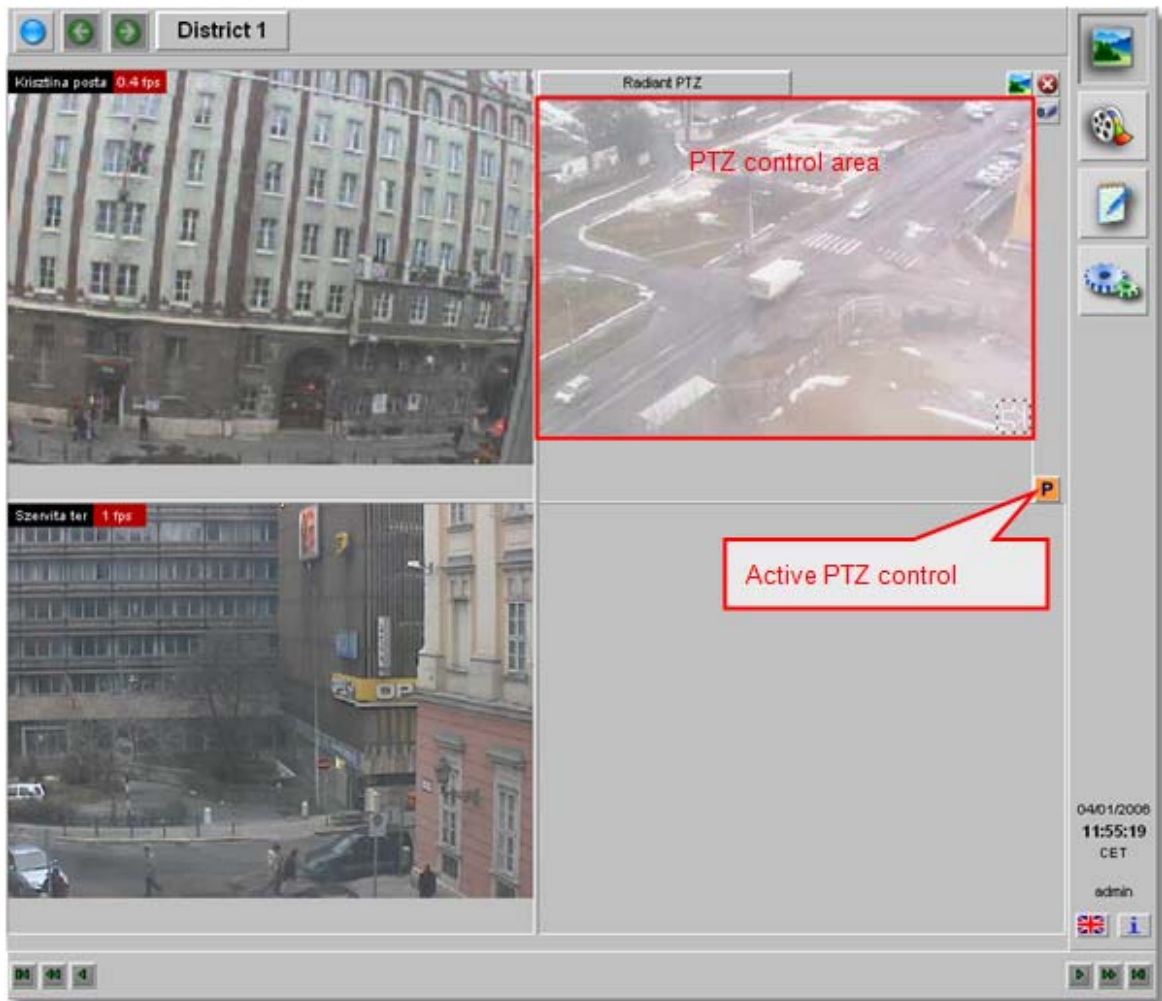

Note: For each user a PTZ priority and allocation timeouts can be defined (see 4.1 *Creating a new user account* on page 30). If another user with equal or higher priority has already assumed PTZ control over the camera, you will be denied control and notified in a window. Then you need to wait until this user surrenders control or reaches his timeout. A user with a higher PTZ priority can take away PTZ control from a user with lower PTZ priority.

Direct PTZ control inside a view port

You have several options for directly controlling PTZ cams: The various modes can be selected via **PTZ->PTZ control mode** in the view port control menu. The default setting is **Continuous** mode and **Center on click**. As an alternate mode also an operation via a **Crosshair** is available.

Continuous mode (available for joystick and mouse operation): Click the mouse in the view port and drag it in the direction where you want the PTZ cam to move. A red line indicates how fast the movement is. When you release the mouse, the movement will stop.

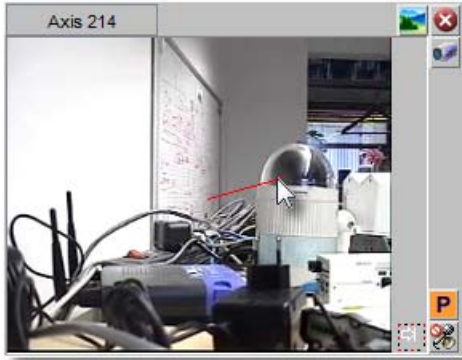

Center on Click: A single mouse click somewhere in the view port commands the camera to center on the mouse click location.

Zooming: Zooming is available via the mouse wheel: zoom-in (forward scroll) and zoom-out (backward scroll). The amount of the zoom will be indicated by 3 red dots after the mouse is released:

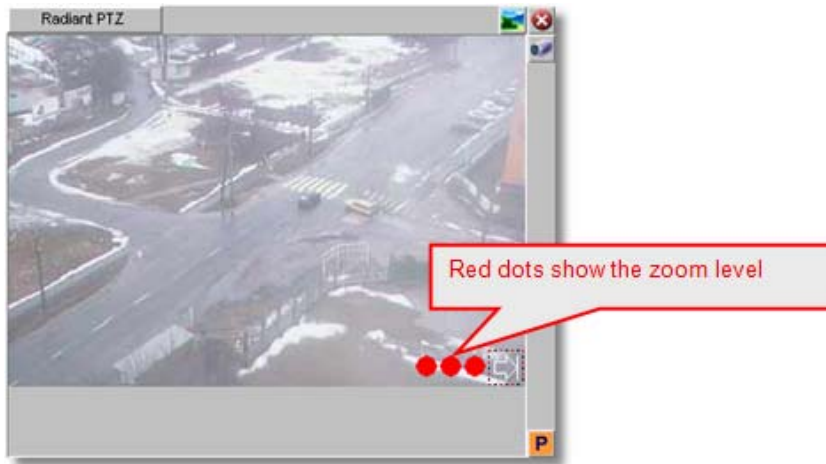

Please note: When PTZ control is enabled, any mouse actions are taken for PTZ control. In order to control the client-based view port zooming (see 6.2.3 *Zooming in a view port and in archive recordings* on page 51), hold down the **CTRL** key while using the mouse.

Crosshair: When this mode is enabled, a crosshair is shown in the view port

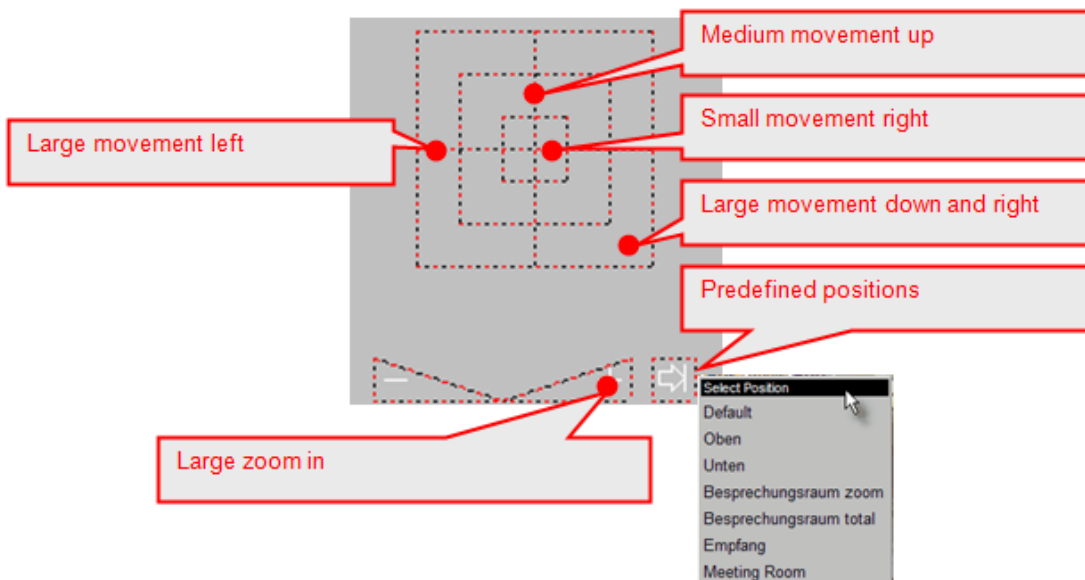

Controlling PTZ cameras with a joystick:

The locally installed version of VisoGuard is able to handle USB joysticks as input device from Java VM 1.4 and newer (for information on how to install the application version locally please refer to *2.3 Working with the installed VisoGuard client* on page 14).

The joystick can be used for panning, tilting the camera, while its buttons for zoom-in and zoom-out operations (which button is used for which operation is assigned during calibration). The joystick must be calibrated before use (found in the System Information menu, beside the language change menu). To "assign" the joystick input focus to a camera, click into the frame while holding the SHIFT and CTRL buttons. This is visible via an in-picture icon drawn when the assignment is successfully done.

Jump to a predefined PTZ position and follow PTZ routes

1. To spot a camera to a predefined PTZ position, click on the right arrow at the lower right corner of the view port and select a position from the list (see *9.2 Defining fixed PTZ positions* on page 69).
2. To automatically follow a predefined PTZ route choose it from **PTZ->Select PTZ route** in the view port control menu of the PTZ camera.
3. In the view port control menu of the PTZ camera, click **PTZ->Select PTZ route->Stop route** to stop control of the PTZ camera.

Stop PTZ control

You can stop PTZ control by pushing the  button or deselect **PTZ->Activate PTZ** control in the view port control menu.

Note: Please do not forget to stop PTZ control; otherwise other users cannot assume control. When you end the VisoGuard client, all PTZ control is automatically released. For further details on user-specific PTZ priorities and timeouts please refer to *4.1 Creating a new user account* on page 30.

9.4.2 Controlling PTZ cameras with motion detection events

It is possible to automatically control PTZ cameras with motion detection events. Please refer to *7.1.4 Controlling PTZ cameras with motion detection events* on page 60.

9.4.3 Scheduling PTZ routes

It is possible to schedule time intervals for PTZ camera to follow predefined routes.

Note: Before you can schedule a route you first must define the route (please refer to *9.3 Defining PTZ routes* on page 69).

To schedule a PTZ route, follow these steps:

1. Choose **Camera admin** from the **System administration** menu. This opens the **Camera admin** dialog.
2. Select a PTZ camera.
3. Press the **Next** button to go to the **Scheduling** dialog.
4. In the menu select **Modify selected camera or group**.
5. Click the **Add** button to add a programming slot to the **Time Intervals field**.
6. Click the **Change** button (now enabled) for a popup menu; select **PTZ route**. This will show the PTZ scheduling settings (see above).
7. Set the **time settings** according to your needs.

8. Select the route from the **Route Name** pop-up menu (in the example above we selected Route 1).
9. Click on **Save** to store the scheduling settings.

Note: You can add several PTZ route schedules for a single camera. This means that you can follow different routes at different times.

10 Administrating VisoGuard servers

This chapter describes how to get status information about an VisoGuard server and how to set server parameters. Further information about administrating servers you find in the document *Thecus VisoGuard 4.3 Server Installation and Administration*.

10.1 Server system information and restarting

VisoGuard offers 2 sets of status information of the running servers in a network.

- The server load display in the main client window
- The System information dialog in the Admin area

10.1.1 Server load display

The server load display is located in the status bar of the main client window and shows the following information:

CPU: xx %	Server CPU load in percent. This display is updated every 5 seconds.
IDB: xx % xx KB/s	Load of Image database (IDB) engine: This parameter shows how busy the server is with saving video data on storage. The actual video data storage rate is displayed below the percent value in Megabytes/sec or Kilobytes/sec. The IDB display does not appear if the server does not record. Note that the IDB load also increases when the server removes video data when the storage is full or recording time limits are reached. IDB details are updated once a minute.
OVR: xx %	Overloaded state of the IDB engine: The IDB engine is overloaded if the server receives more video data from the cameras than it can record (save on storage). In this case the server will drop frames. OVR shows the percent of dropped frames. If the label OVR does not appear then the server can save every incoming frame.
SWP: xx MB	Swapping: This display appears if the server starts heavy swapping, which means that the amount of main memory of the server is insufficient. If this is situation persists, the server must be extended with additional RAM.

10.1.2 System information dialog in the Admin area

1. Choose **System information** from the **System administration** menu. This opens the **System information** dialog.

State of NetAVIS nodes			
Name	State	License	Archive (fps / KBps) - Monitor (fps / KBps)
netavis (netavis, 1.9.0.101.180)	Running / OK	U: 10(1) C: 10(2) L: P, E	7 / 346 - 0 / 4

Choose an action:

The table shows the connected servers and their state:

Name shows the name of the server and the VisoGuard version running.

State shows whether the server is running and if there is a failure (the server in the screenshot above is running OK).

License shows the license of the VisoGuard server:

- **U:** shows the number of total and in parentheses the number of used-up user licenses. If the number contains an “R” then it is a floating license from a remote licensing server.
- **C:** shows the number of total and in parentheses the number of used-up camera licenses. If the number contains an “R” then it is a floating license from a remote licensing server. If the number of cameras exceeds the license limit, then in parentheses first the number of disabled cameras is shown and then, after a slash, the number of allowed licensed cameras.
- **L:** shows the license type and the licensed product edition and modules:

License type:

- P = permanent license
- D = demo license

Licensed product edition:

- B = VisoGuard Basic edition
- C = VisoGuard Core edition
- E = VisoGuard Enterprise edition
- X = VisoGuard Extended edition
- AS = VisoGuard Application service edition

Licensed modules:

- ABS = ABS transcoding for low-bandwidth connections
- LNT = Layout navigation tool
- OPC = iCAT object tracking
- RAO = removed and abandoned object detection
- SB = camera sabotage detection
- SNAP = SNAP (XML integration interface)

You can display the current license key string by entering the following URL in a web browser
<http://IP-address-of-your-server:8080/arms/servlet/BrowserServlet?cmd=showlicensekey>.

For further information about licensing please refer to the manual *Thecus VisoGuard 4.3 Server Installation and Administration*.

Archive shows the sum of fps and Kbytes per second of archiving on that host.

Monitor shows the sum of fps and Kbytes per second of all logged in users.

Please note that you usually only see the status of your server. If you want to monitor the status of other VisoGuard servers as well, you have to make other servers known to your server (please refer to *11 Working with interconnected VisoGuard servers* on page 82).

- To show the details of a server, double click an entry or select a server in the table and then choose **Details** from the **System** menu. Now you see detailed information for the selected server:

Partition	Type	Status	Capacity (MB)	Used %
ctrl: 1 dev: 0	I	OK	105265	21
ctrl: 1 dev: 1	I	OK	105265	21
ctrl: 2 dev: 0	I	OK	105265	8
ctrl: 2 dev: 1	I	Failure	-	-
ctrl: 0 dev: 0	DB	OK	-	-

Here you see the hard disk partitions and their state:

Partition ctrl: shows the number of the hard disk controller; **dev:** shows the hard disk number on the controller. On the screen dump we have 5 disks on 3 controllers.

Type indicates the type of the partition: **DB** is a database holding configuration and event data and **I** is an image partition that holds the actual video image data.

Status indicates whether there is a failure on the partition. Such a failure needs to be reported to your VisoGuard Administrator.

Capacity indicates the size of the partition in MB.

Used % shows how much space of the partition is used.

3. Click on the **Back** button to leave the server details dialog and go back to the list of servers.

10.1.3 Restarting VisoGuard

1. Choose **System information** from the **System administration** menu. This opens the **System information** dialog.
2. Select a server in the table. In the **System** menu you have the following actions available:

Stop VisoGuard system: This stops all video system processes but does not shut down the server.

Switch off server: This shuts the server down.

10.2 Setting VisoGuard server parameters

VisoGuard allows you to set several server parameters. To access them, follow these steps:

1. Choose **Host admin** from the **System administration** menu. This opens the **Host admin** dialog.
2. Select your own server indicated by bold face (default is **netavis**). Here you see the Hostname, Network name or IP address and VisoGuard Host ID of your server (are read only). The VisoGuard Host ID is needed for working with distributed VisoGuard server (see next section).
3. If this server is cooperating with other servers, then the settings for synchronization group may be relevant (see also *11 Working with interconnected VisoGuard servers* on page 82):

If this server should be part of a synchronization group then enter the name of the synchronization group in the field **Name of synchronization group**. If this server should be the master of the synchronization group, then select the check box **Master of the sync group**. Please refer to *11.1.2 Keeping multiple users servers in sync (synchronization groups)* on page 82 for a general explanation of synchronization groups.

Please note: Modification of configuration data is only possible at the master of the synchronization group and not at the slaves (as they will be updated by the master automatically). As long as there is no master in the sync group (which may happen during set up of the sync group) no modification is possible at all.

4. Click on the **Next** button. Now you see the Server **Parameters** dialog. Following settings are available:

Field label	Description
Event storage period (days)	Defines how many days events are stored. Any events that are older than these days will be deleted from the event database.
Max number of events stored on server	Defines how many events can be stored in the event database. For each event more than the defined max. number of events the oldest event will be deleted. Please note that both settings, the storage period and the max. number of events, together constrain the event database.
Server timezone abbreviation	Defines the server timezone. Available values are:

Field label	Description
	<p>GMT, Greenwich Mean Time CET, Central European Time GMT+1 MIT, Pacific/Apia GMT-11 HST, Hawaiian Standard Time GMT-10 AST, America/Anchorage GMT-9 PST, Pacific GMT-8 MST, Mountain GMT-7 CST, Central GMT-6 EST, Eastern GMT-5 PRT, America/Puerto_Rico GMT-4 CNT, America/St_Johns GMT-3.5 AGT, America/Buenos_Aires GMT-3 ART, Africa/Cairo GMT+2 EET, Europe/Istanbul GMT+2 EAT, Africa/Addis_Ababa GMT+3 MET, Asia/Tehran GMT+3.5 NET, Asia/Yerevan GMT+4 PLT, Asia/Karachi GMT+5 IST, Asia/Calcutta GMT+5.5 BST, Asia/Dacca GMT+6 VST, Asia/Saigon GMT+7 CTT, Asia/Shanghai GMT+8 JST, Asia/Tokyo GMT+9 ACT, Australia/Darwin GMT+9.5 AET, Australia/Sydney GMT+10 SST, Pacific/Guadalcanal GMT+11 NST, Pacific/Auckland GMT+12</p>
Timeout for IP cameras (sec)	Defines the time after which the message “Camera not responding” appears in the Online Monitor.
Retry count for IP cameras, after which an event is generated	Defines the number of retries after which the server raises a “camera not reachable” event. The Timeout for IP cameras (sec) multiplied by this retry count gives the number of seconds, after which an event is generated when an IP camera is unreachable.
Maximum login time for the “guest” user (sec)	Defines the time after which the guest user is forced to logout. If the value is 0, then the guest is never forced to logout.
Timeout for server-server communication (sec)	Defines the time after which an event “Connection lost to server ...” is generated and the cameras mounted from that server disappear from the camera tree (only the root element of the mounted camera tree remains visible, painted in red).
Server network address for camera access	This setting is only important for IP cameras that must actively access the server (e.g. for FTP upload with in-camera motion detection) and only when the server is not accessible by the cameras at its set IP address but at a

Field label	Description
	different address (e.g. due to address mapping). Per default this address always reflects the IP address of the server. You can enter an IP address or a network name.
List of IP addresses from which URL control is enabled	<p>URL control is one way to enable third-party applications to start actions via URL-encoded strings (send http GET request to an VisoGuard server). The server upon receiving these special URL requests executes the actions as if they would have been generated internally.</p> <p>URL control is only enabled for computers whose IP addresses are entered in this fields (comma separated list). All other requests are blocked. Please refer to the <i>Release Notes</i> for further details on URL control.</p>
Transcoding bandwidth limit for live view video streams (kbit/s)	Bandwidth limit per session for transcoded outgoing live view streams (ABS). Zero means no transcoding and no limit for live view video streams. Please read <i>2.5 VisoGuard Transcoding™ for low-bandwidth client-server connections (ABS)</i> on page 19 for choosing the best limit values.
Transcoding bandwidth limit for archive playback video streams (kbit/s)	Bandwidth limit per session for transcoded outgoing archive playback streams (ABS). Zero means no transcoding and no limit for archive playback streams. Please read <i>2.5 VisoGuard Transcoding™ for low-bandwidth client-server connections (ABS)</i> on page 19 for choosing the best limit values.
Transcoding bandwidth limit for archive export streams (kbit/s)	Bandwidth limit per session for transcoded outgoing archive export streams (ABS). Zero means no transcoding and no limit for archive export. Please read <i>2.5 VisoGuard Transcoding™ for low-bandwidth client-server connections (ABS)</i> on page 19 for choosing the best limit values.
IP address of network interface (NIC) for bandwidth limitation	<p>IP address of the network interface (NIC) for which bandwidth limitation is applied. If zero, then the bandwidth limit is applied in total for all available network interfaces. If transcoding is switched on, then it will only be applied to connections of this NIC.</p> <p>If you enter the keyword NUS instead of the IP address of the NIC then only traffic to a NUS (VisoGuard user server) is transcoded. Local client connections to this server will not be transcoded. It also works this way if the server has only 1 NIC for all traffic to cameras, local clients and a NUS.</p>
Total outgoing bandwidth limit (kbit/s)	Total bandwidth limit for all outgoing connections of the specified network interface (NIC).
RTSP streaming port	<p>Port number generally used for RTSP communication (e.g. for some MPEG cameras).</p> <p>Please note that modifying the value here does not change the RTSP port setting in the cameras. The cameras need to be configured separately for the RTSP port.</p>

Field label	Description
Image database AES encryption (0=no encryption, 1 or 2=encryption)	<p>This defines whether the image data are encrypted with AES.</p> <p>Value 0 switches off encryption (default).</p> <p>Entering the value 1 or 2 will switch on AES encryption of the video recording. Value 1 means the system will store the encryption key on a local server disk.</p> <p>Value 2 will store the key on a USB device (formatted with FAT32), which has to be plugged into the server. If the device is not accessible, then archive access is not possible.</p> <p>Prior to inserting the USB device, a writable directory "nek" must be created on the device (this can be done under Windows, for example). VisoGuard will search for this directory and store the key file in it. After the USB device is detected and the key has been written to it the first time, an event with following text is generated: "IDB encryption started, USB device can be removed now for creating backup copy". At this time the USB device can be removed from the server, and a backup copy of the directory "nek" can be created. Note that the stick must be inserted again before any archive query is started.</p> <p>Warning: Loss of the encryption key stored on the USB device will make archive access impossible! Also, encryption needs much more CPU power than no encryption (see also <i>1.3 VisoGuard data security</i> on page 5).</p>

- To modify any of these values, select **Modify host** in the menu, set the values and then press **Save**.

11 Working with interconnected VisoGuard servers

VisoGuard allows you to work with the resources of interconnected (remote, distributed) VisoGuard servers. The concept is similar to accessing files on a remote file server. You can import single cameras or whole groups of cameras from other VisoGuard servers and you can also export your locally defined cameras to other VisoGuard servers. You can work with remote cameras as if they would be local (e.g. you can also access their archive, modify their parameters or even add new cameras to remote sites).

You can also define whether events are to be propagated between servers.

A special feature are so called synchronization groups of servers. A synchronization group allows you to automatically synchronize server configuration data (like user configuration data and camera configuration data) between servers.

Before you can do any of these things, you first have to make both servers known to each other. You can do that by adding the other server as remote server on each of the machines. The next section describes how to do that.

Please note: This chapter just provides a basic introduction to working with interconnected servers. For further details on setting up and administrating a distributed AS system please refer to the manual *Thecus VisoGuard 4.3 Distributed AS Administration*.

11.1 Basic concepts of interconnected VisoGuard servers

In a single server system an VisoGuard server does multiple things: store camera recordings, run video analytics on camera streams, store events in the event database, handle user clients.

In a bigger system with many cameras and users, because of workload a single server is not capable of doing all those things at once. Therefore multiple servers can be installed to handle the workload.

11.1.1 Camera servers (NCS) and user servers (NUS)

In a network of multiple servers the individual servers usually work in different roles:

Camera servers (NCS = Network Camera Server): A camera servers (NCS) mainly manages cameras, it stores recordings and optionally runs video analytics on the video streams of the connected cameras. It also stores the events related to the connected cameras. A NCS usually does not serve any user clients directly but it offers its cameras to user servers for mounting.

User server (NUS = Network User Server): A user server handles user clients. It usually mounts cameras from multiple camera servers and also receives events from them. Thus a user connecting to a NUS can have access to the cameras of all camera servers. A user server usually does not manage any cameras directly and does not do any recording or any video analytics. However, it usually does store the events of all the mounted NCS in its central event database.

11.1.2 Keeping multiple users servers in sync (synchronization groups)

In a larger system that requires multiple user servers (NUS) it can be cumbersome to manually keep all user configuration data synchronized between all user servers. Thus VisoGuard offer the concept of so called synchronization groups.

In a synchronization group a master user server automatically propagates its configuration data (complete user configuration data and camera configuration data, customer-specific resources like icons and layout navigation data) to all the other user servers in the same group. Thus the master user server is the single point of all user administration (in fact changes at slave servers are no longer possible). Any changes are automatically propagated to the other users servers in the same group.

Whenever a server is added as a slave to a synchronization group, it will automatically be synchronized with the data from the master sync server.

The synchronization group settings can be modified in *10.2 Setting VisoGuard server parameters* on page 78 (see *10.2 Setting VisoGuard server parameters* on page 78).

Please note:When a server is added as a slave to a synchronization group, any configuration data that is not also existing on the master server will be deleted and overwritten by the data of the master server. So please be careful when you work with synchronization groups.

Also: When users connect to slave servers they cannot modify their user settings, this can only be done when they are connected to the master user server. Thus layout navigation tool (LNT) project creation and icon uploads should always be done at the master user server.

11.2 Adding and defining a remote VisoGuard server

1. Choose **Host admin** from the **System administration** menu. This opens the **Host admin** dialog. In the menu select **Add host**.

Fill in the basic information of the desired remote VisoGuard host (server):

Field label	Your input
Hostname	This is the name you give to the remote VisoGuard server. It does not necessarily have to match the actual name of the remote server.
Network name or IP address	This is the network name or IP address of the remote VisoGuard server. Please note that you have to add Port 8080 to the address of the server. For example, the IP address would then look like 192.168.0.7:8080 or my-visoguard-server.com:8080 .
Comment	A descriptive text.
Observer Host ID	This is an internal ID that uniquely identifies the remote server. The ID of an VisoGuard server can be obtained by reading its own entry under the Host Admin tab.

2. Now you can define what you want to do with the remote VisoGuard server. Set options according to your requirements:

Field label	Your input
Send local events to remote server	Check this option if you want that your local events are sent to the remote host.
Import of cameras from remote server enabled	Check this option if you want to import cameras from the remote server.
Export local cameras to remote server	Check this option if you want to export cameras of your server to the remote server. If this option is not enabled the remote server cannot access your cameras.

Field label	Your input
Monitor remote server status	Check this option if you want to monitor the status of the remote server in System information dialog.
Upgrade software on remote server (=upgrade slave)	Check this option if you want to allow automatic distributed software upgrades of the remote server initiated by your current server. In such a case your current local server is the upgrade master and the remote host the upgrade slave. For details about distributed upgrades please refer to the manual <i>Thecus VisoGuard 4.3 Server Installation and Administration</i> .
Accept software upgrades from remote server (=upgrade master)	Check this option if you want to accept automatic distributed software upgrades of the current server (=slave) initiated by the remote server (=master). In such a case your current local server is the upgrade slave and the remote host the upgrade master. For details about distributed upgrades please refer to the manual <i>Thecus VisoGuard 4.3 Server Installation and Administration</i> .
Request license from remote server (=license master)	Check this option if your current VisoGuard server should check out licenses from the remote server (=license master). For details about floating network licenses please refer to the manual <i>Thecus VisoGuard 4.3 Server Installation and Administration</i> .
Use secure connection (HTTPS)	Select this checkbox if you want to use an encrypted connection between the two servers (SSL HTTPS). Please be aware that an encrypted connection needs more CPU resources on both servers. See also <i>1.3 VisoGuard data security</i> on page 5.

3. Click on **Save** to save your settings. Now you are ready to import cameras or camera groups from a remote VisoGuard server.

11.3 Working with cameras of another server

In order to work with cameras from another VisoGuard server, following prerequisites must be fulfilled:

- The servers must know each other (see *11.2 Adding and defining a remote VisoGuard server* on page 83)
- The server that exports cameras must have the option **Export local cameras to remote server** set (see *11.2 Adding and defining a remote VisoGuard server* on page 83)
- The server that works with cameras of another server must have the option **Import of cameras from remote server enabled** set (see *11.2 Adding and defining a remote VisoGuard server* on page 83)

After you mount remote cameras you can work with them as if they would be connected to this server. You can access live streaming via the Online Monitor or you can access the archive. If you have the appropriate administrator rights you can also modify camera settings like PTZ, scheduling or motion detection.

11.3.1 Mounting cameras of another server

1. Choose **Camera admin** from the **System administration** menu. This opens the **Camera admin** dialog.
2. In the menu select **Mount remote camera or group**.

3. Select from **Known remote machines** menu item this remote VisoGuard host from where you want to import cameras

Now the basic data of this remote VisoGuard host are shown again (hostname, IP address).

4. By clicking on **Camera on remote host** selection dialog the whole camera tree from the selected remote host appears and you can select a single camera or group to be imported, e.g. **PTZ** camera on remote host **netavis-hu**.

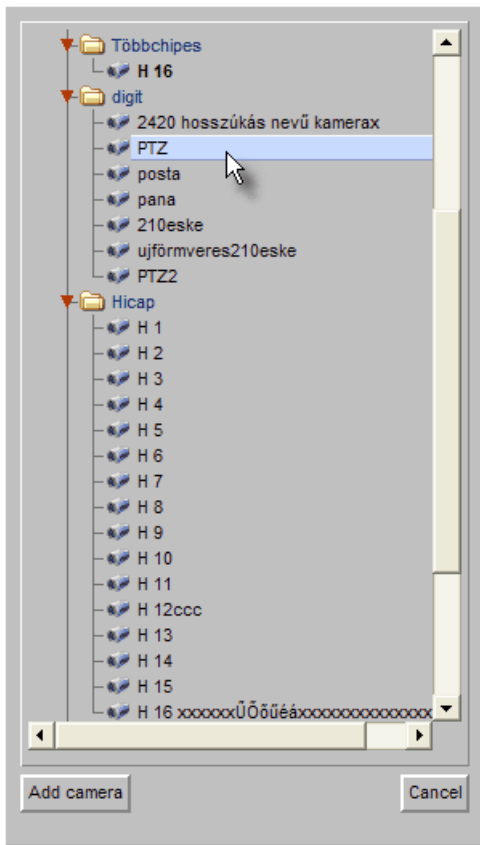

Confirm your selection by clicking on **Add camera** button.

Now your camera tree shows this imported camera or group in **bold** with the name of the remote server in brackets, e.g. **PTZ [netavis-hu]**.

If the remote server is not reachable, the mounted cameras are not shown in the tree; only the top point of the mounted camera tree appears in red color.

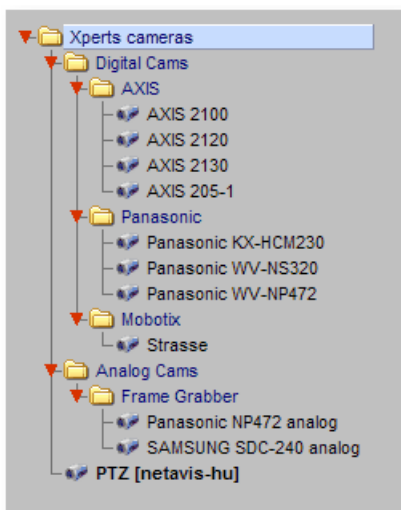

5. With imported cameras you can work the same way as with local cameras. For example, you can display them in a view port in the Monitor (please refer to *5.2 Selecting cameras* on page 36).

11.4 Working with events of remote servers

VisoGuard servers can forward their events to other servers. Such forwarded events are stored in the event database of the generating server itself and also in the event database of the server(s) that receive the events.

Event entries in the event database of remote servers look the same as local events, they just start with the remote server's name and not with the name of the local server. The same kind of search and listing is available as with local events.

In order to receive events from another VisoGuard server, following prerequisites must be fulfilled:

- The servers must know of each other (*11.2 Adding and defining a remote VisoGuard server* on page 83)
- The server that exports events must have the option **Send local events to remote server** set (*11.2 Adding and defining a remote VisoGuard server* on page 83)

11.5 Monitoring remote servers

You can monitor the status of remote servers in the **System information** dialog (see *10.1 Server system information and restarting* on page 75). Before you can do that you have to tell your server to monitor the remote server by checking the option **Monitor remote server status** (see *11.2 Adding and defining a remote VisoGuard server* on page 83).

12 VisoGuard on mobile devices

You can access an VisoGuard server also from mobile devices like PDAs and mobile phones. This version supports the live viewing of video streams from an VisoGuard server.

This chapter describes how you can install and run VisoGuard on such mobile devices.

12.1 Supported devices

Currently VisoGuard allows you to install the mobile client on these systems:

- Apple iPhone and iPad with OS 3.0 or newer

For further details refer to the VisoGuard start page.

12.2 Installing the VisoGuard client on a mobile device

12.2.1 Apple iPhone

1. Go to the iTunes Store and search for "NETAVIS".
2. Install the VisoGuard application on your iPhone.

12.3 Running the VisoGuard client on a mobile device

12.3.1 Apple iPhone

1. Start the VisoGuard iPhone client.
2. Connect to an VisoGuard server and login. Please note that you have to **add Port 8080** to the address of the server. For example, the IP address would then look like **192.168.0.7:8080** or **my-visoguard-server.com:8080**.
3. When you get the camera tree tap on a camera to show the live stream.
4. To zoom a camera view in and out in pinch your fingers together or apart. You can also double-tap (tap twice quickly) to zoom in, then double-tap again to zoom out.

13 Working with Layout Navigation

VisoGuard offers powerful layout navigation features that allow you to navigate based on layouts, floor plans, and also other images. In this chapter you learn how to use the layout navigation features.

Please note: Since Layout navigation is licensed separately of VisoGuard you need a valid license in order to work with these features. See also *10.1 Server system information and restarting* on page 75 for details about what license you have.

13.1 Basic concepts and how it works

The VisoGuard layout navigation tool (LNT) allows you to define a hierarchy of **graphical layouts** that correspond to various aspects of your physical environment (section *13.4.1 Planning your layout hierarchy* on page 89 provides details on how to plan the hierarchy).

Layouts that belong together and other related settings can be grouped together in so called **projects**. Depending on the user rights, several users can access and share the same projects and by thus layouts and settings.

On each layout you can place **camera control icons** that correspond to cameras on an VisoGuard server. The camera icons on layouts are interactive, i.e. trigger certain actions when you move the mouse over them or click on them. Such actions can be to show camera live image streams or its recording archive in the corresponding VisoGuard client running on the same client workstation.

On layouts you can also define polygon-shaped **zones** that group certain cameras together and that allow for smart ways of highlighting on events and for good synchronization with the VisoGuard client.

Additionally, you can also display and acknowledge VisoGuard **events** in the tool.

All information used by the LNT (e.g. project and layout definitions, background images, and camera mappings) are stored on the VisoGuard server. Users can use the same LNT information as long as they load the same LNT project, regardless on which client they work.

In a typical installation you would run the VisoGuard client on one screen and the layout navigation tool on another screen (see *2.4 Client multi-window and multi-screen operation* on page 17 for details). However, you can of course run both tools on the same screen as well.

Please note: Currently LNT can only display MJPEG camera streams (MPEG camera streams are not yet supported).

13.2 Installing the layout navigation tool

The layout navigation is available only in the locally installed client which currently runs on MS Windows platforms only (see *2.1 Introduction to the VisoGuard client* on page 10).

The Layout Navigation is installed automatically when you install the locally installed VisoGuard client. Please refer to *2.3 Working with the installed VisoGuard client* on page 14.

Note: Currently the layout navigation tool is available only in the locally installed client. For running the layout navigation tool Microsoft .NET 2.0 or a newer version must be installed.

13.3 Starting the layout navigation tool

You can start the layout navigation tool the same way as you can start the installed VisoGuard client. Please refer to 2.3.2 *Starting the installed VisoGuard client* on page 15.

The layout navigation tool (LNT) main window looks like this:



13.4 Setting up a project and defining layouts (Editing mode)

In order to setup LNT for work you have to execute a few steps:

- Plan your layout hierarchy
- Select and upload images to be used for layout backgrounds
- Define the hierarchy and map your cameras

In the next subsections we will cover the above topics.

13.4.1 Planning your layout hierarchy

Before you create a project and start to upload graphics images for your layouts it makes sense to plan the layout hierarchy. For example, if your VisoGuard system covers a building then you could have an overview layout image for the building and then separate subordinate layout images for each floor.

For an even bigger setup: If your VisoGuard system covers a whole area with several office or plant buildings then you could have an overview layout image for the whole area and subordinate layout images for each of the buildings and additional images for the parking lots, driveways, fence sectors, etc. Each of the building layouts then in turn could have subordinate layout images for parts of the

building like each of the floors. Each of the floors could additionally have subordinate layouts for parts of the floor or even for each of the rooms. Thus you can create hierarchies at arbitrary levels of detail.

13.4.2 Switching to editing mode and creating a project

1. Switch to editing mode by choosing **Project > Switch to editing mode** or by pushing the editing button  at the right side of the tool bar.
In editing mode the LNT window now has added a new control icon list.
2. Create a new project by choosing **Project > New project** and then enter a name of the new project in the newly opened dialog. Push **OK**. Now you start to upload background images for your layouts.

13.4.3 Creating layouts and mapping cameras, I/O contacts, and zones

After you planned your layout hierarchy you have to select appropriate images for the various layouts. The layout navigation tool supports popular image graphics file formats like GIF, JPEG, PNG, etc.

Depending on your needs and the available screen resolution for the layout navigation tool (LNT) you have to choose the size (in pixels) for your images. Please keep in mind that the LNT also supports image scaling to fit the available space.

Creating a new layout

To create a new layout, follow these steps:

1. In the layout navigation tool (LNT) switch to customizing mode by choosing **Project > Switch to editing mode** or by pushing the editing mode button  at the right side of the tool bar.
2. In the **Layout** menu choose **New...**, which opens the **Layout** dialog:

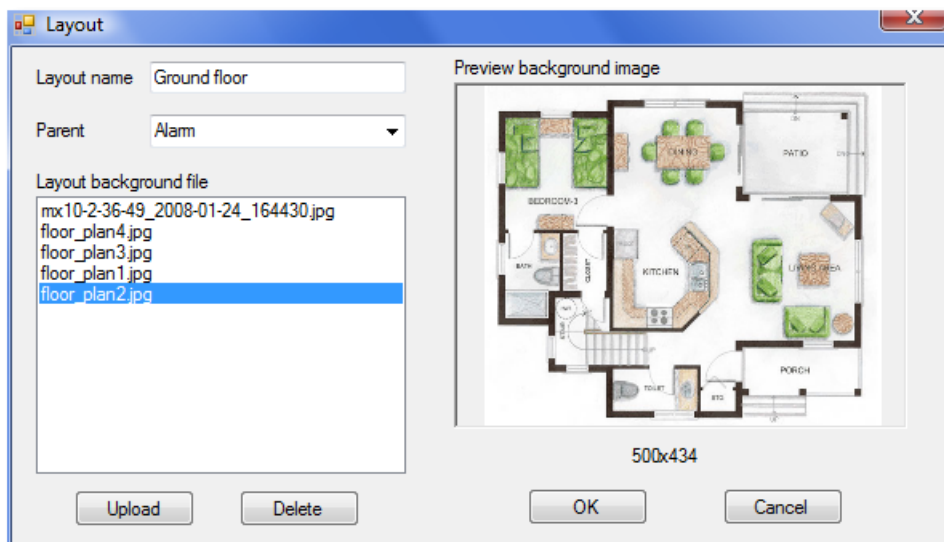

3. Enter a name for the layout.
4. Select a background image from the list of available uploaded images or push **Upload** to upload a new background image for the layout (you can also delete uploaded images from the server by selecting an image from the list and pushing **Delete**).
5. If the layout is subordinate to another layout then choose the parent layout from the **Parent** pop-up menu (you can change the layout hierarchy later on via the **Layout > Properties** dialog).
6. Push **OK** to create the layout.
Now you see that the layout with the selected background image has been created.

Mapping cameras

1. From the list of controls at the right side drag a camera control icon with the mouse onto the layout and drop it there. A camera selection dialog opens automatically. Choose the I/O device and contact and push **OK**. Now you have mapped the camera to your camera icon.

Repeat the above step for other cameras.

You can delete a camera by selecting it with the mouse by choosing **Delete** from the right mouse button pop-up menu.

Mapping I/O contacts

LNT allows you to work with I/O devices, i.e. you can display the state of input contacts and you can switch output contacts of I/O devices (for configuring I/O devices, please refer to *15.7 Configuring I/O devices* on page 127). You can place such I/O controls onto layouts like camera controls.

Here are some icons representing the various states of input and output contacts:



1. From the list of controls at the right side drag an I/O control icon with the mouse onto the layout and drop it there. An I/O contact selection dialog opens automatically. In the list you only see I/O devices that are configured with VisoGuard. Choose the device and the I/O contact and push **OK** (depending on whether the I/O control represents an input or an output contact, you get only input or output contacts the contacts list of the selected device). Now you have mapped the I/O device to your camera icon.

Repeat the above step for other I/O contacts.

You can delete an I/O contact control by selecting it with the mouse by choosing **Delete** from the right mouse button pop-up menu.

Defining zones

LNT allows you to group several cameras on a layout into so called zones that can have arbitrary polygon shapes.

Cameras belong to a zone as long as they are positioned inside the boundaries of the zone. You can place an arbitrary number of zones onto a layout.

Here is how you can create a zone:

1. Select a layout from the layout hierarchy.
2. Drag the **Zone field** with the mouse from the controls list at the right side and drop it onto your layout. Where you drop the zone field control with the mouse will be the first corner of the polygon shape and you can now define the zone shape by clicking at further corners. To finish the zone definition, close the polygon shape. Alternatively you can create a rectangular zone by pressing the **CTRL** key while moving the mouse.
3. Per default the zones will be named "Zone-1", "Zone-2" and so on. You can rename and delete a zone via the right mouse button pop-up menu. Zones can be moved by dragging them with the mouse.

Please note: A zone can trigger certain actions, e.g. when you click with the mouse on it, a zone can show all cameras belonging to the zone in the VisoGuard client. This, for example, will either create a new view in the VisoGuard client or map it to an existing view depending on the names of the views and zones. Therefore the name of a zone can be of importance.

Here is how the mapping works for the LNT action **Show zone live in Observer Client:**

If there is an VisoGuard view that has the same name as the LNT zone and that also contains all the cameras of the LNT zone, then this view is exposed in the VisoGuard client. Otherwise a new view is created with the name of the zone. Details for zone actions can be found under *13.5.3 Modifying zone control appearance and behavior* on page 94.

Linking layouts with link fields

LNT offers link fields to easily navigate between layouts. Link fields can be placed on layouts and are resizable grey areas. Clicking on a link field in Navigation mode will open the “linked” layout.

Here is how you can link layouts via link fields:

1. Drag the **Link field** from the controls list at the right side and drop it onto your layout. Where you drop the zone field control with the mouse will be the first corner of the polygon shape and you can now define its shape by clicking at further corners. To finish the link field definition, close the polygon shape. Alternatively you can create a rectangular link field by pressing the **CTRL** key while moving the mouse.
After you finished defining the shape of the link field, a dialog is opened offering the available layouts for this link field. Choose a layout by double clicking or by pushing the **Select** button. This defines which layout is to be opened when the link field double clicked in Navigation mode.
2. Choose **Save** from the **Project** menu to save your changes.

Now you can repeat the steps above to create your overall layout hierarchy. You can switch back to Navigation mode by clicking the navigation mode icon  at the right side of the tool bar.

Defining a default project

To define a default project to be loaded when LNT is started, follow these steps:

1. In the **Project** menu choose **Set default project...** which opens a dialog listing all available projects. Choose a project and push **Select**. To not load a default project, choose **<No default project>** from the list.

Now this project will be loaded automatically at startup.

Defining a home layout

A home layout can be defined which is automatically shown when the project is loaded. You can set the home layout by following these steps:

1. In the layout hierarchy select the layout that you want to set as home layout.
2. In the **Layout** menu choose **Set as home**.

Now this layout will be opened automatically when the project is loaded.

13.5 Customizing the behavior and appearance of controls

LNT currently has 2 types of controls that can be modified: camera controls and zone controls (the link field control cannot be modified).

LNT lets you modify several aspects of the appearance and behavior of these control icons:

- Icon image and appearance.

- What happens when you move the mouse over a control icon or when you click on it.
- What happens on certain events originated by VisoGuard related to cameras or zones.

Also you can create new control icons with your own icon images.

13.5.1 Modifying camera control appearance and behavior

1. Switch to editing mode by choosing **Project > Switch to editing mode** or by pushing the editing button  at the right side of the tool bar.
2. In the control icon list click on a camera icon with the right mouse button and choose **Modify...** from the pop-up menu. This opens the **Modify control** dialog:

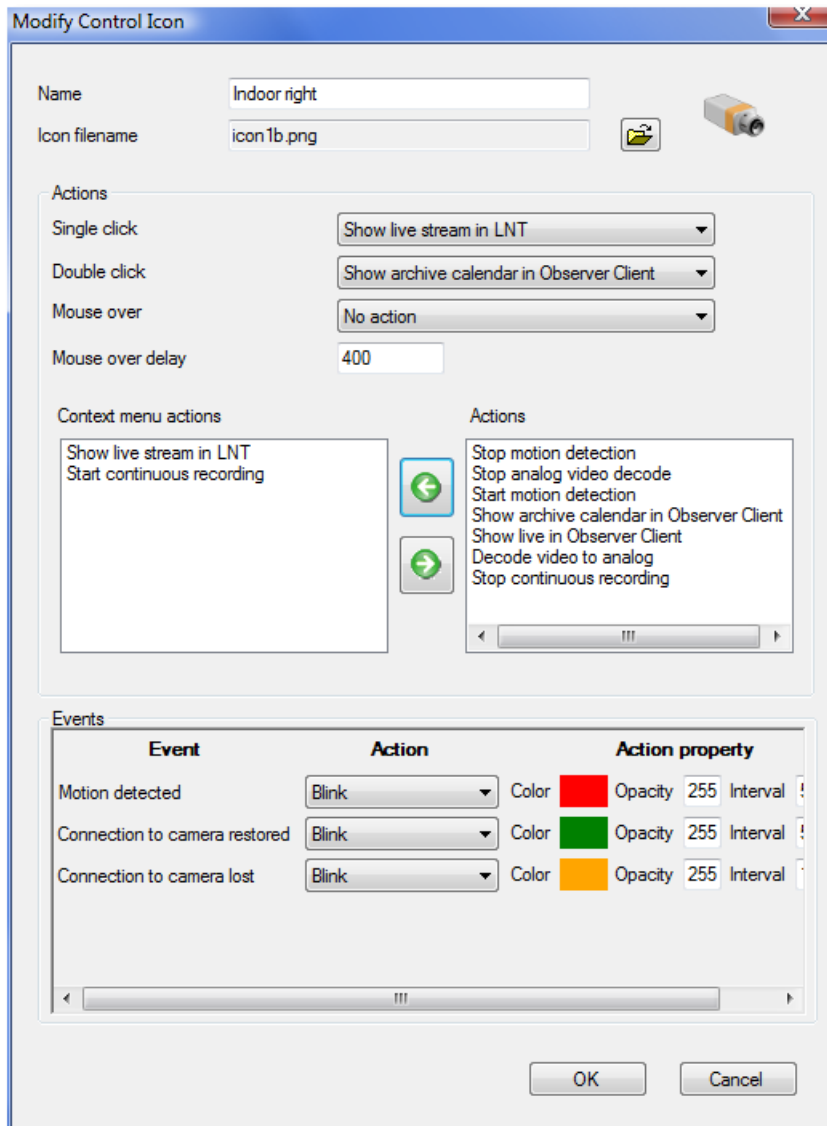

In this dialog you can define the control name and image and which actions are to be performed on certain mouse operations and events.

Actions

The possible **Actions** are:

- **Show live in Observer Client** exposes a large live view of the respective camera in the VisoGuard client that runs on the same machine. If no client is running on the same machine, then nothing is happening.
- **Show archive calendar in Observer Client** exposes the archive calendar view of the respective camera in the VisoGuard client that runs on the same machine. If no client is running on the same machine, then nothing is happening.
- **Show live stream in LNT** opens a window showing a live stream of respective camera in LNT. If this action is bound to **Mouse over** then the window will be automatically closed when the mouse is moved away from the camera icon. If this action is bound to **Single click** or **Double click**, then the window stays until it is closed manually. To close all such windows, you can select **Close all live streams** in the **View** menu.
- **Start/Stop continuous recording** starts or stops continuous recording of the camera in VisoGuard. It actually sets or deletes the **Enable interval** checkbox in the camera admin's **Scheduling** dialog. Please be aware that there must be at least one continuous recording interval for the camera for this to work (refer to *6.1.1 Programming continuous timed recordings* on page 45 for details).
- **Start/Stop motion detection** enables or disables motion detection of the camera in VisoGuard. It actually marks or unmarks the **Enabled** checkbox in the camera admin's Motion detection dialog. Please be aware that there must be at least one detection field definition for the camera for this to work (refer to *7.1.2 Basic configuration of server-based motion detection* on page 58 for details).
- **Start/Stop analog video decode** allows the control of special devices that decode IP-based network video signals to analog video signals. This is useful for example for security center video walls that are driven by analog video signals. The configuration of these special devices must be done in configuration files (please refer to the Release Notes or to the customization documentation).

Events

You can also modify the behavior of control icons for certain events, like **Connection to camera lost** or **Motion detected**.

3. Click **OK** to save changes.

13.5.2 Adding a new camera control

1. Switch to customizing mode by choosing **Project > Switch to editing mode** or by pushing the customize button  at the right side of the tool bar.
2. In the control icon list click the right mouse button and choose **Add control...** from the pop-up menu. This opens the **Add new control icon** dialog which is essentially the same as the **Modify control icon** dialog (see *13.5.1 Modifying camera control appearance and behavior* on page 93).

Here you can define the icon name and image and which actions are to be performed on certain mouse operations.

You can also modify the behavior for certain events, like color and blinking.

3. Click **OK** to create the new camera control icon.

13.5.3 Modifying zone control appearance and behavior

1. Switch to editing mode by choosing **Project > Switch to editing mode** or by pushing the editing button  at the right side of the tool bar.
2. In the control icon list click on a zone icon with the right mouse button and choose **Modify...** from the pop-up menu. This opens the **Modify Zone** dialog:

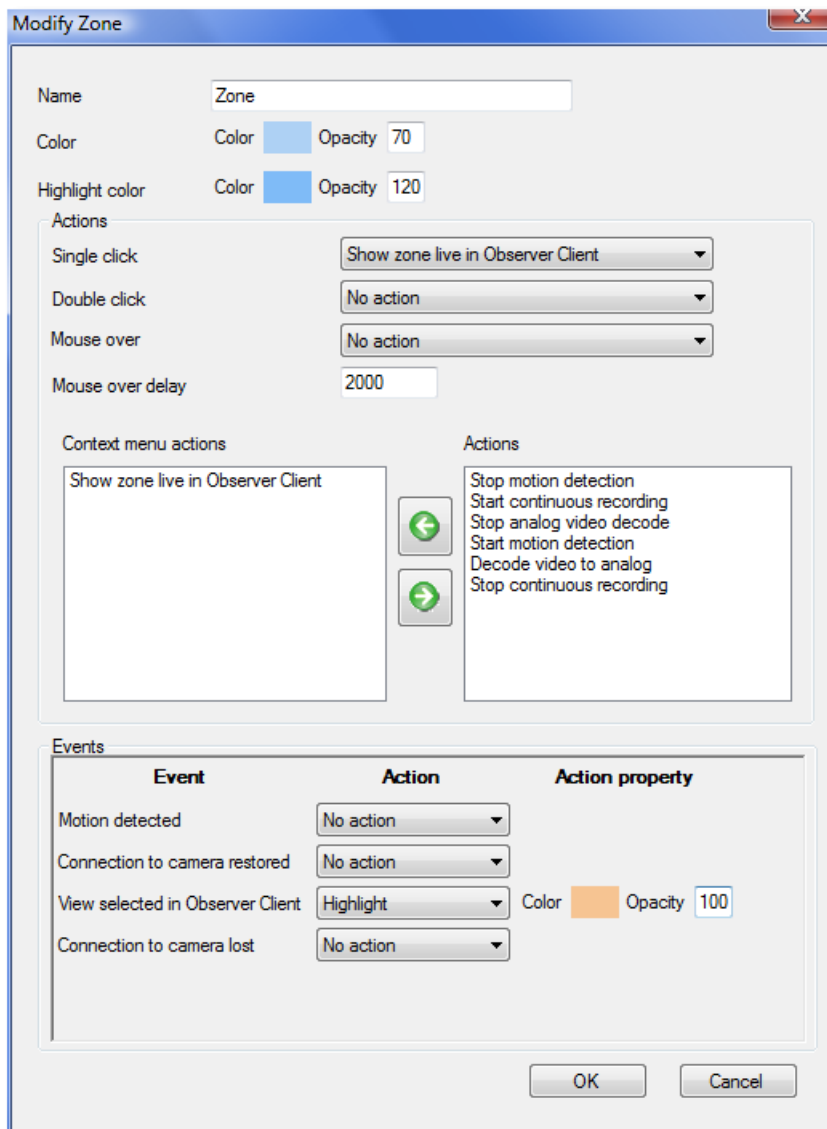

In this dialog you can define the color of the zone and which actions are to be performed on certain mouse operations and events.

Actions

The possible **Actions** are basically the same as for the camera control (see *13.5.1 Modifying camera control appearance and behavior* on page 93) with one addition:

- **Show zone live in Observer Client** exposes the corresponding view of the zone in the VisoGuard client that runs on the same machine. If there is an VisoGuard view that has the same name as the LNT zone and that also contains all the cameras of the zone, then this view is exposed in the VisoGuard client. Otherwise a new view is created with the name of the zone.

Events

You can also modify the behavior of zones of this type for certain events, like **Connection to camera lost** or **Motion detected**.

The event **View selected in Observer Client** works this way: If there is an LNT zone with the same name as the view in VisoGuard then the corresponding action is triggered.

3. Click **OK** to save changes.

13.5.4 Adding a new zone control

1. Switch to customizing mode by choosing **Project > Editing mode** or by pushing the customize button  at the right side of the tool bar.
2. In the control icon list click the right mouse button and choose **Add zone...** from the pop-up menu. This opens the **New zone** dialog which is essentially the same as the **Modify Zone** dialog (see 13.5.3 *Modifying zone control appearance and behavior* on page 94).
3. Click **OK** to create the new zone control.

13.5.5 Modifying I/O contact control appearance and behavior

1. Switch to editing mode by choosing **Project > Switch to editing mode** or by pushing the editing button  at the right side of the tool bar.
2. In the control icon list click on an I/O control icon with the right mouse button and choose **Modify...** from the pop-up menu. This opens the **Modify control** dialog:

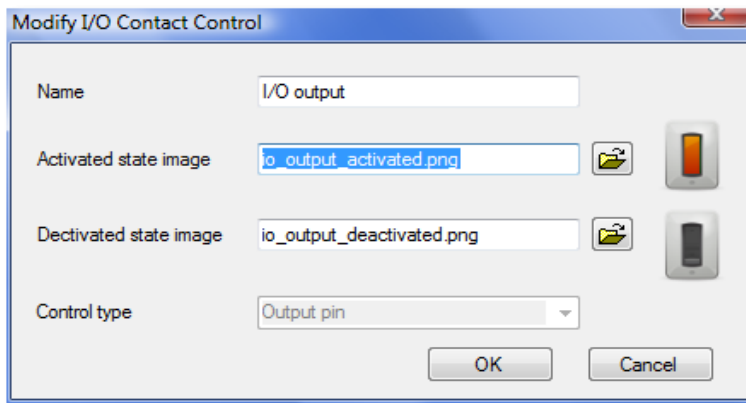

In this dialog you can define the name of the control and the two images for activated and deactivated states. The control type (Input or Output) cannot be modified.

3. Click **OK** to save changes.

13.5.6 Adding a new I/O contact control

1. Switch to customizing mode by choosing **Project > Switch to editing mode** or by pushing the customize button  at the right side of the tool bar.
2. In the control icon list click the right mouse button and choose **Add I/O contact...** from the pop-up menu. This opens the **Modify I/O Contact Control** dialog (for an screen shot see 13.5.5 *Modifying I/O contact control appearance and behavior* on page 96).

In this dialog you can define the name of the control and the two images for activated and deactivated states. Also set the **Control type**: An **Input contact** displays the state of the input contact of an I/O device. An **Output contact** allows you to switch an output contact of an I/O device.

For example, for an input contact that shows the state of a gate barrier you can use images that reflect the open and closed state of the barrier.

3. Click **OK** to create the new camera control icon.

13.6 Layout navigation and operation (Navigation mode)

Switch to Navigation mode by clicking the navigation mode icon  at the right side of the tool bar or by choosing **Project > Switch to navigation mode**.

Please note: An VisoGuard client must be running under the same user on the same client workstation so that it can be controlled by the layout navigation tool.

13.6.1 Peeking live video of mapped cameras

The default behavior of some camera icons is that you can peek at live video of mapped cameras by moving the mouse pointer over a camera icon. Then the live video stream will be shown on top of the layout:



As soon as you move the mouse pointer away from the icon, the stream disappears. This behavior can be changed with the **Modify control icon** dialog (see *13.5.1 Modifying camera control appearance and behavior* on page 93).

13.6.2 Showing a camera in the VisoGuard client

When you **single click** a camera icon in LNT then the corresponding camera will be shown in full size in the VisoGuard client. This behavior can be changed with the **Modify control icon** dialog (see *13.5.1 Modifying camera control appearance and behavior* on page 93).

Please note that the VisoGuard client has to be running on the same machine being connected to the same server in order for the feature to work (the client will not be started automatically by LNT).

13.6.3 Positioning to the camera recording archive in the VisoGuard client

When you **double click** a camera icon in LNT then recording archive of the corresponding camera will be shown in the VisoGuard client running on the same machine. This behavior can be changed with the **Modify control icon** dialog (see *13.5.1 Modifying camera control appearance and behavior* on page 93).

Please note that the VisoGuard client has to be running on the same machine being connected to the same server in order for the feature to work (the client will not be started automatically by LNT).

13.6.4 Navigating in the layout hierarchy

You can position to a layout by clicking its name in the layout hierarchy.

You can also jump to a connected layout by clicking a link field.

13.6.5 Working with events in the layout navigation tool

The layout navigation tool (LNT) also allows you to view and acknowledge VisoGuard events.

Please note: Event handling will only work if the user has the rights to work with events.

When a new event occurs in VisoGuard, then it is displayed in the **Event list** at the right side of the LNT window (the **Event list** can be switched on and off in editing mode by choosing **View > Event list**).

The Project settings define what happens when a new event is coming in (see *13.6.7 Project settings* on page 99): The layout that contains the primary control for related to the event can be exposed automatically and also the control that is related to the event can be highlighted (blinking rectangle).

Additionally a longer description is displayed in the **Event description** field at the bottom of the window (which also can be switched on and off in **Editing** mode by choosing **View > Event description**).

You can acknowledge an event by pushing **Acknowledge** in the Event description field. Acknowledged events will be removed from the Event list. Pressing **Cancel** sets the state of the event to seen (visited) but does not acknowledge it.

Please note that for each camera, a primary control can be defined that is exposed when a new event is generated. You can set the primary flag for a camera icon by right-clicking on the icon in editing mode and choosing **Primary** from the pop-up menu.

Generally, events in LNT can have the following states (indicated by different colors of the event entry):

- New (unseen) events are shown as grey (if it is selected then it is shown in green).
- Seen (visited) events are shown in blue.
- Acknowledged events are removed from the list.

When there are several new events, then LNT offers you to see (visit) them one by one. The exact behavior of the visiting and how the event state can be set to seen (visited) can be defined in the Project settings (see *13.6.7 Project settings* on page 99). You can, for example, mark a new event as seen and jump to the next event by moving the mouse over the blinking control.

13.6.6 Camera status display

LNT allows you to display certain states of cameras in the mapped camera and zone control icons. Examples for states that can be displayed are recording, motion detection active, broken connections, etc.

An example of a status display is:



This camera currently is recording and has motion detection enabled.

To modify the status display settings, follow these steps:

1. Switch to editing mode by choosing **Project > Switch to editing mode** or by pushing the customize button  at the right side of the tool bar.
2. Choose **Project > Camera status display settings...** which opens the **Status display settings** dialog.
This dialog now allows you to define the status settings for camera and zone controls. You can modify the status display settings according to your needs. You can also enable/disable certain status displays by setting the **Enabled** flag.
3. Push **OK** to save your changes or **Cancel** to discard them.

When you switch to navigation mode, the new settings become effective.

13.6.7 Project settings

The layout navigation tool (LNT) allows you to set several project settings that define the workings of the tool. In the **Project** menu choose **Project settings...** to open the **Project settings** dialog.

Here you can set the following values:

Setting	Description
Show home layout on load	Defines whether the Home layout is shown when the tool is started. In order for that to work you must have a home layout defined.
Highlight zone under mouse cursor	Defines whether zones will be highlighted when you move the mouse over them. This can be useful for distinguishing when the mouse cursor is over the zone or over the camera control icon on top of the zone.
Automatically jump to layout on event	In case of an event this setting defines whether the layout that contains the primary control related to the event should be exposed.
Visiting order of events	Defines in which order new events are to be visited.
Set event state to seen (visited) by	When a new event comes in or an existing event is selected, the related control blinks or is highlighted. This setting defines with what mouse operation the state of the event can be set to seen (visited) (blinking is stopped).
Only suggest events of mapped images for visiting	If this checkbox is marked then only events of mapped cameras will be suggested for automatic visiting. If it is unchecked then all events will be suggested.
Standard view size for layouts	Defines the default image size, either Fit image or Full size .
Event list insertion mode	Defines whether new events in the Event list are inserted from the Top or from the Bottom .

14 Video analytics with iCAT

iCAT is the video analytics toolkit of VisoGuard. It provides powerful and easy-to-configure object detection and tracking mechanisms as well as a statistics module with integration to the event management system EMS.

iCAT can also interface to 3rd-party video analysis toolkits and algorithms (contact Thecus Technology Corporation).

Please note: Since iCAT and some functions are licensed separately of VisoGuard you need a valid license in order to work with these features. See also *10.1 Server system information and restarting* on page 75 for details about what license you have.

14.1 iCAT highlights

- iCAT **works with any camera** that can deliver an MJPEG stream (this covers also analog cameras that are connected via a video server or directly connected to a video grabber card in the VisoGuard server).
- iCAT is **easy to configure** and setup and it **works in difficult situations** also with extreme camera perspectives.
- It offers **flexible scheduling** of iCAT definitions depending on date and time. Thus you can have different setups for weekdays and weekend as well as day and night.
- The **Smart Tripwire™** function for **people and object counting** prevents wrong and double counting and works even with the most difficult entrance situations.



- The Smart Tripwire™ also allows **detecting wrong direction** movements of people and objects.
- **Powerful and robust object tracking** and **event triggering** can be constraint to **object sizes, speeds, and other properties**.



- The **Visual Statistics™** module allows you to view various object statistics in an intuitive way.

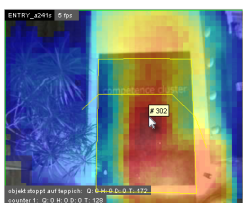

- Event statistics can be **exported to Excel XLS** for further processing.
- All iCAT detection annotations are **available for live streams and in archived recordings**.

- **Seamless integration** with the VisoGuard event management system EMS and other VisoGuard functions. Additionally iCAT offers **camera sabotage detection** and **lighting change detection**.
- iCAT algorithms have been tuned for the **highest performance** and **least burden on the server**.

14.2 Basic iCAT concepts

iCAT basically consists of the following components that are tightly integrated with VisoGuard:

1. An object detection and tracking engine analyzes the video stream and tracks detected objects. Please be aware that an object has to show consistent motion first in order to be detected and tracked.
2. An event logic engine with configurable event triggers decides when a tracked object triggers an event.
3. A real-time statistics module stores statistical information about various aspects of objects like object sizes and speeds.

For setting up a camera with iCAT you essentially configure the following things:

Object tracking region:

The object tracking region defines the part of the camera view in which iCAT is detecting and tracking objects. For each camera you can define one tracking region that is either the full camera view or a part of it in the form of a polygon or rectangle. No object will be detected or tracked outside of this tracking region. Since the CPU overhead caused by iCAT is directly proportional to the size (area) of all the active tracking regions of all active cameras of a server, optimizing the tracking regions will save CPU power. Region definitions can also be used to mask out problematic areas in the scene as well (e.g. swaying trees).

For each tracking region you can also define what object statistics should be measured by iCAT. Such statistics can then be visualized.

Event triggers: Each camera can have several event triggers that define under what conditions an event is generated by the detected objects. Event triggers only work inside of the object tracking region. Examples of event triggers are people or object counters and detectors of stopped or started objects. The CPU load caused by event triggers compared to the tracking region is negligible.

Scheduling: The standard VisoGuard scheduling mechanisms are also used for scheduling (activating) various iCAT setups. For example, it is possible to have different iCAT settings for weekdays and weekends.

14.2.1 Considerations for setting up a system with iCAT

Camera selection and placement

Though iCAT is able to analyze video captured by any type of supported camera, using a device with higher image quality will result in better detection and tracking.

Generally the iCAT algorithms work with in- and outdoor cameras as well as for different perspectives. The configuration of the algorithms in VisoGuard is pretty simple, as you will see below.

For people and object counting, the best results are possible if the camera is mounted overhead downward looking.

Please note: Setting up iCAT definitions for PTZ cameras is problematic since most of the iCAT functions require a fixed camera position.

Video streams and formats

iCAT works with any video camera. If the camera can provide an MJPEG stream, iCAT uses this format because it is the most efficient for video analytics. If the camera provides only MPEG formats (MPEG-4, H.264, and MxPEG) then iCAT can also work on these streaming formats. However, please be aware that video analytics in MPEG streams requires a lot more CPU power than in MJPEG streams since the decoding is much more complex (for multi-stream operation please see below). Also video analytics in MPEG streams causes additional delays because it works on groups of pictures or frames (so called GOPs). As a rule of thumb, iCAT adds a delay of approximately 1 GOP duration. Depending on the actual MPEG cameras model, A GOP duration is between 0.5 and 1 sec (see also [3.2 Adding a new camera and setting basic properties](#) on page 21).

Analog cameras that are connected either via video server or directly connected to an VisoGuard server with a grabber card installed are also supported, of course.

iCAT generally works on CIF (or QVGA or nearest) resolution. This is a good balance between accuracy and CPU overhead. If there is a continuous recording enabled for the camera, iCAT uses this stream for its algorithms and does not cause additional bandwidth. If the size of the stream is bigger than CIF, iCAT downscales it to CIF (or QVGA or nearest) resolution. Any pixel measures that are available in iCAT are relative to this resolution.

Future releases will also allow you to select higher resolutions for the iCAT algorithms.

CPU load of iCAT (performance issues)

iCAT runs on the server and works very efficiently. The CPU overhead caused by iCAT is directly proportional to the following aspects (see also [14.2 Basic iCAT concepts](#) on page 101):

- The size (area) of all the active tracking regions of all cameras of a server. This means that optimizing the tracking regions will save CPU power. The number and shape of event triggers is negligible.
- The video processing speed (in fps) of iCAT.
- The streaming format (see above)

An VisoGuard server running with iCAT on standard (not high-end) desktop server hardware can easily handle approximately 10 iCAT-enabled cameras with standard settings.

Additional CPU power (like quad core), enhanced RAM speed, and bigger L2 caches help to boost the iCAT performance.

Multi-streaming operation with iCAT

As indicated above iCAT normally needs much more CPU power for processing MPEG streams (MPEG-4, H.264, and MxPEG) than for processing MJPEG streams. Therefore VisoGuard can pull two parallel streams from the camera if the camera supports that: one MPEG stream for live viewing and recording and 1 additional MJPEG stream for iCAT operation.

In the **Default settings** dialog in **Camera Admin** the checkbox **Multi-stream allowed** enables or disable this dual-stream iCAT processing (see also [3.2 Adding a new camera and setting basic properties](#) on page 21).

If this checkbox is selected and live viewing or recording is active with an MPEG stream with a frame rate of more than 5 fps or a resolution bigger than VGA 640x480 pixels then VisoGuard will try pull a second MJPEG stream in QVGA fine from the camera for iCAT processing (please note that this stream will be pulled even if the checkbox **Allow JPEG streaming** is deselected). The frame rate of this second stream depends on the iCAT function.

Please note: Dual-streaming iCAT processing will not be activated automatically after selecting the Multi-stream checkboxes. Please restart the server or stop and start (disable/enable) all iCAT functions of the camera in order to activate dual-streaming iCAT after changing the Multi-stream selections.

Object detection

Depending on the sensitivity and other settings iCAT currently detects objects of 8x8 pixels or bigger in size (in a QVGA image). Only moving objects are detected. New objects are detected by iCAT after a few video frames. How quickly objects are detected is also influenced by the sensitivity setting.

iCAT video processing speed

If the objects you want to track move very quickly across your camera view you will require a higher video processing speed of iCAT than if they move slowly across your camera view. As a rule of thumb the optimal frame rate for object detection and tracking is 8-10 fps.

Please note: Not the absolute speed of the objects influences what processing speed you need but the relative speed that these objects have in your camera view. This relative speed is influenced by the camera perspective and distance from objects.
Example: Cars on a highway are moving very fast. However if you look at them with a camera from a larger distance and from a perspective with a flat angle the cars are actually moving pretty slowly in your camera's view. Therefore you can choose a slower video processing speed even for such fast objects like cars on a highway.

14.3 Setting up a camera for video analytics with iCAT

14.3.1 Defining an object tracking region

1. Choose **Video analysis (iCAT)** from the **System administration** menu. This opens the **Video analysis (iCAT)** dialog.
2. Select a camera in the camera tree and in the menu select **Add new definition**.
3. In the **Type** pop-up menu choose **Object tracking region**.
4. In the **Identifier** text field enter a name for this region.
5. Choose whether you want a **Polygon** or **Rectangle** shape by checking the respective check box.
6. Now you can draw the region with the mouse in the preview pane. For a polygon you just click with the mouse to define the corners of the polygon. You close the polygon by crossing an existing edge or by double clicking with the mouse. Here is an example of a tracking region:



Please note: As indicated in *14.2 Basic iCAT concepts* on page 101 and *14.2.1 Considerations for setting up a system with iCAT* on page 101 objects will only be detected and tracked inside a tracking region. Event triggers will only work inside the boundaries of tracking regions. On the other hand, making the object tracking region as small as possible helps you to save CPU power of your VisoGuard server. Also be aware that the tracking region should approximately at least be twice the size of the biggest objects you want to track.

7. Now you have to set the configuration parameters of the tracking region:

Field label	Your input
Indoor camera	Enable this setting if the camera is an indoor camera. Indoor setting usually is best for rooms not bigger than 10x10m and objects not farther away than 15m. Disable this check box for outdoor environments. Experiment with this setting, if the detection/tracking quality is not ideal.
Overhead downward looking	This setting only takes effect if Indoor camera is enabled. Enable the setting if the camera is overhead mounted and downward looking. This will improve object separation and the accuracy of object counting. In our example above, the camera is an indoor camera and mounted overhead downward looking.
Sensitivity	Usually this setting should be left at Normal . Only if you are not satisfied with the object detection quality or behavior you can try to modify this setting. If you want a sharper object detection and separation, you can set the Sensitivity to High or Very high . Also for example, if you want to detect very small objects, you can improve the sensitivity. The Sensitivity also influences how fast new objects are detected. Higher Sensibility means quicker object detection, lower means slower detection. For environments that are very noisy visually and that cause too many objects to be detected, the Sensitivity can be set to Low or Very low .
Max object lifetime (sec)	Defines how long a detected object is tracked before it is dismissed by iCAT (i.e. no longer treated as object but essentially becoming background). After an object is being dismissed by iCAT, if it starts moving again, it will be detected as new object. The setting is useful to lower the probability of falsely tracked objects which remain in the scene for too long. If you experience that objects are no longer tracked though they are visible and moving, this value might have to be increased.
Max stopped object lifetime (sec)	Defines how long a detected object that stopped is tracked before it is dismissed by iCAT (i.e. no longer treated as object but essentially becoming background). After an object is being dismissed by iCAT, if it starts moving again, it will be detected as new object. The setting is useful for removing false detections (usually caused by environmental changes) which often remain still for a longer period. If objects in the scene usually stop longer than this time limit, then set it higher.

Field label	Your input
Video processing (fps)	This defines at what frame rate the iCAT algorithms operate. If the objects you want to track move very quickly across your camera view you want to improve the speed. If they move slowly across the camera view you can decrease the speed. See also <i>14.2.1 Considerations for setting up a system with iCAT</i> on page 101.
Tolerance radius for stopped object (%)	Defines when how much a stopped object may move away from its stopping position before iCAT detects it to move again. There is a virtual circle centered at the object's center point. In this field one can define its radius proportional to the size of the object. If the object's center remains inside the circle it is detected as stopped. When this value is set close to 100%, slowly moving or loitering objects will be detected as stopped. It also influences the statistics of stopped objects.

8. Push **Next** to get to the **Statistics** settings for the tracking region. Here you can define what statistics iCAT should collect. Later on these object tracking statistics can be visualized (see *14.4.2 Displaying Visual Statistics™* on page 119. Currently, the following measurements are available: Object counts, speeds, sizes (also for stopped objects).
9. Push **Save** to create the tracking region. Later on you can modify the tracking region settings.
10. If you did not yet define the scheduling for iCAT activities, then after you save the first iCAT definition for a camera, you will be prompted for whether you want to edit the scheduling now.

Click on the **Yes** button if you want to configure the scheduling now (refer to section *14.3.9 Scheduling iCAT operation and recording* on page 115 for further information).

Click on the **No** button if you do not wish to schedule the recording or if you want to do that later.

Please note:

- If you add a new iCAT definition, it will automatically be assigned to all iCAT schedules of the camera. If you do not want that, you have to remove the assignment manually (see *14.3.9 Scheduling iCAT operation and recording* on page 115).
- If a definition is not assigned to a schedule then it will not be activated and no archive recordings will be made and no events will be generated.

iCAT event settings

You can also specify event-related properties on an iCAT definition:

1. You can also choose a specific **Icon** and **Sound** for the event when it is shown in the event task bar.
2. You can also define a special event priority for events generated by the trigger by setting the value **Priority of generated event**. Please note that the event priority is a relative priority whereby 100 is the default priority (see also *8 Handling events* on page 63).
3. The check boxes **Save event in event list** and **Do not save event in event list** allow you to selectively override the general setting for the camera schedule which is defined in *14.3.9 Scheduling iCAT operation and recording* on page 115).

14.3.2 Defining an event trigger for people and object counting (Smart Tripwire™)

Once you have created a tracking region, you can create an arbitrary number of event triggers inside this tracking region. Event triggers define under what conditions an VisoGuard event is generated by

iCAT. Such events can trigger automatic recording and are stored in the normal VisoGuard event database that can be queried and exported.

Currently iCAT supports the following event triggers:

- A Smart Tripwire™ for directional people or object counting. This tripwire is directional, so if you want to count objects in two directions you would create two tripwires.
- A polygon or rectangle that creates an event when an object either crosses the field, stops inside the field or starts moving inside the field.

Please note: Before you can define an object trigger you must first define an object tracking region (see 14.3.1 *Defining an object tracking region* on page 103).

Here are the steps for creating a counting tripwire:

1. Choose **Video analysis (iCAT)** from the **System administration** menu. This opens the **Video analysis (iCAT)** dialog.
2. Select a camera make sure that you have a suitable tracking region defined that allows for object counting.
3. Choose **Add new definition** from the menu.
4. In the **Type** pop-up menu choose **Event trigger**, which will expose the configuration settings.
5. Under the camera preview choose the **Tripwire** check box for directional people or object counting.
6. Now you can draw the tripwire line with the mouse in the preview pane. You just click with the mouse to define the corners of the polygon. You finish the line by double clicking with the mouse. Here is an example of a tripwire:



This tripwire triggers a counting event whenever an object moves from the green area across the red tripwire. The tripwire is “smart” as it only counts objects that have first been detected in the green area and move across. It would not count the object if it would first be detected in the non-green area, then moved across the line into the green and then move across the tripwire from the green to the non-green area. It also would not double count an object that would have moved across the line twice.

Hints: To count **incoming and outgoing people or objects** you would create two different tripwires with opposite green areas which would both trigger events. You can also use the tripwire to **detect objects moving in the wrong direction**.

Please note: As indicated *14.2.1 Considerations for setting up a system with iCAT* on page 101 objects will only be detected after a few frames. Therefore an object can move a bit before it is actually detected as object by iCAT. Therefore it makes sense to have the green area big enough to allow iCAT time for the object detection. If that is not the case it might be possible that quickly moving objects are not detected before they cross the tripwire and therefore would not be counted. The ideal settings depend on viewed (relative) object speed and iCAT video processing frame rate.

Do not place the tripwire too close to areas where objects exit the scene (e.g. image borders, doors), because they might disappear before crossing the tripwire. It is a good practice to draw the tripwire about half the average object size away from such areas.

7. You can also define when an object is counted by either selecting **Object center point**, **Any point of object**, or **Whole object**. The most appropriate choice in most cases **Object center point** because of its robustness.
8. When you push the **Next** button you can define additional constraints for the event creation. You can limit the counting only to certain object sizes, certain aspect ratios, and a certain speed. Currently those measures are definable in pixels (please keep in mind that the resolution iCAT works on is either CIF or QVGA depending on the aspect ratio of the camera). Future releases of iCAT will allow for real world measures.

Zero values in these fields mean that there is no constraint.

Hint for constraining the object size or speed: The size is the area of the object in pixels and the speed is also measured in pixels per second. To know what object sizes or speeds you want to filter it is helpful to watch a few objects passing the triggers and switch on the object markers. These markers show the size and speed of the object in pixels. These are exactly the same measures that you can use for the trigger. Here is an example of an object marker (Object ID is [10], object size is 9110 pixels, speed is 208 pixels/sec):

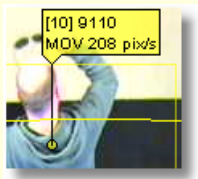

The section *14.4.1 Displaying iCAT information in the Online monitor and when playing recordings* on page 117 shows you how to view object markers.

9. In the **Identifier** text field enter a name for this event trigger. An example name for a people counter would be "Entrance 1 incoming".
10. You can also choose a specific **Icon** shown and **Sound** played for the event when it is shown in the Event list. Or you can choose to have no icon or no sound associated with the event.
11. You can also define a special event priority for events generated by the trigger by setting the value **Priority of generated event** (see *8 Handling events* on page 63 for further details on event priorities).
12. The check boxes **Save event in event list** and **Do not save event in event list** allow you to selectively override the general setting for the camera schedule which is defined in *14.3.9 Scheduling iCAT operation and recording* on page 115).
13. Push **Save** to save your definition.

Please note:

- If you add a new iCAT definition, it will automatically be assigned to all iCAT schedules of the camera. If you do not want that, you have to remove the assignment manually (see *14.3.9 Scheduling iCAT operation and recording* on page 115).
- If a definition is not assigned to a schedule then it will not be activated and no archive recordings will be made and no events will be generated.

iCAT event settings

You can also specify event-related properties on an iCAT definition:

1. You can also choose a specific **Icon** and **Sound** for the event when it is shown in the event task bar.
2. You can also define a special event priority for events generated by the trigger by setting the value **Priority of generated event**. Please note that the event priority is a relative priority whereby 100 is the default priority (see also *8 Handling events* on page 63).
3. The check boxes **Save event in event list** and **Do not save event in event list** allow you to selectively override the general setting for the camera schedule which is defined in *14.3.9 Scheduling iCAT operation and recording* on page 115).

14.3.3 Defining an event trigger for object starting and stopping

In addition to object counting, iCAT also offers to detect stopping and starting objects in a defined field.

Here are the steps for creating an event trigger for object starting and stopping:

1. Choose **Video analysis (iCAT)** from the **System administration** menu. This opens the **Video analysis (iCAT)** dialog.
2. Select a camera and make sure that you have a suitable object tracking region defined that allows for object counting (see *14.3.1 Defining an object tracking region* on page 103).
3. In the menu select **Add new definition**.
4. In the **Type** pop-up menu choose **Event trigger**, which will expose the configuration settings.
5. Under the camera preview choose the **Rectangle** or **Polygon** check box.
6. Now you can draw the field with the mouse in the preview pane. For a polygon you just click with the mouse to define the corners of the polygon. You close the polygon by crossing an existing edge or by double clicking with the mouse.
7. Now select on what object behavior you want to trigger an event: When an **Object is crossing field**, when an **Object starts moving in field**, or when an **Object stops in field**. You can also define when an event is triggered by either selecting **Object center point**, **Any point of object**, or **Whole object**.
8. In the field **Min. time for stopping, staying inside (sec)** you can enter a minimum time required for an object that either stops or stays inside a field before an event is triggered.
9. When you push the **Next** button you can define additional constraints for the event trigger. You can limit the counting only to certain object sizes, certain aspect ratios, and a certain speed. Currently those measures are definable in pixels (please keep in mind that the resolution iCAT works on is either CIF or QVGA depending on the aspect ratio of the camera). Zero values in these fields mean that there is no constraint.

Hint for constraining the object size or speed: The size is the area of the object in pixels and the speed is also measured in pixels per second. To know what object sizes or speeds you want to filter it is helpful to watch a few objects passing the triggers and switch on the object markers. These markers show the size and speed of the object in pixels. These are exactly the same measures that you can use for the trigger. Here is an example of an object marker (Object ID is [10], object size is 9110 pixels, speed is 208 pixels/sec):

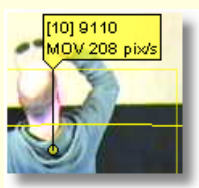

The section *14.4.1 Displaying iCAT information in the Online monitor and when playing recordings* on page 117 shows you how to view object markers.

10. In the **Identifier** text field enter a name for this event trigger.
11. Push **Save** to save your definition.

Please note:

- If you add a new iCAT definition, it will automatically be assigned to all iCAT schedules of the camera. If you do not want that, you have to remove the assignment manually (see *14.3.9 Scheduling iCAT operation and recording* on page 115).
- If a definition is not assigned to a schedule then it will not be activated and no archive recordings will be made and no events will be generated.

iCAT event settings

You can also specify event-related properties on an iCAT definition:

1. You can also choose a specific **Icon** and **Sound** for the event when it is shown in the event task bar.
2. You can also define a special event priority for events generated by the trigger by setting the value **Priority of generated event**. Please note that the event priority is a relative priority whereby 100 is the default priority (see also *8 Handling events* on page 63).
3. The check boxes **Save event in event list** and **Do not save event in event list** allow you to selectively override the general setting for the camera schedule which is defined in *14.3.9 Scheduling iCAT operation and recording* on page 115).

14.3.4 Defining sabotage detection

iCAT offers intelligent features for detecting three types of camera sabotage actions:

- Camera defocused
- Camera covered
- Camera moved

Please note: For sabotage detection an object tracking region is NOT needed.

When initializing the camera for sabotage detection please make sure that the camera has the correct focus setting and that the scenery and brightness is stable.

Here are the steps for installing an iCAT-based sabotage detection:

1. Choose **Video analysis (iCAT)** from the **System administration** menu. This opens the **Video analysis (iCAT)** dialog.
2. Choose a camera and in the menu select **Add new definition**.
3. In the **Type** pop-up menu choose **Sabotage detection**, which will expose the configuration settings.
4. Select any of the three sabotage detection types.
5. In the **Identifier** text field enter a name for this sabotage detection.
6. Push **Save** to save your definition.

Please note:

- If you add a new iCAT definition, it will automatically be assigned to all iCAT schedules of the camera. If you do not want that, you have to remove the assignment manually (see *14.3.9 Scheduling iCAT operation and recording* on page 115).
- If a definition is not assigned to a schedule then it will not be activated and no archive recordings will be made and no events will be generated.

Background information on sabotage detection algorithms

Sabotage detection uses three detector algorithms to generate events for camera moved, defocused and covered.

The camera movement detector tries to locate a couple of strong (= has high contrast) points across the entire picture. Then it searches for them on each of the following frames, while continuously creating new points to keep adapting to a new scenery. A "camera moved" event occurs when a given number of these points are lost for a while.

The focus change detector acts like the auto focus algorithms in digital cameras. It estimates the average sharpness of the picture and produces an event if this sharpness changes abruptly. A "focus lost" event is produced if the sharpness of the picture decreases below a threshold, and a "focus gained" event if the sharpness is increased above a threshold. Both thresholds are based on average sharpness values of previous frames.

The camera covered detector uses a brightness analyzer that calculates the average brightness of the picture for each frame and if something strange happens tries to find out what has happened (light switched off, light switched on or just a person in dark clothes passed by). It does so by analyzing a sample of average brightness values collected in previous frames.

The result of these three detectors are combined to give the final alarm event (camera moved, camera covered, focus lost/gained, brightness change)

Possible reasons of missed or wrong detections

As mentioned above the camera movement detector works with high contrast points on the picture and the focus change detector checks the sharpness of the picture (measuring the sharpness of edges). Logos or date and time text fields generated and placed on the picture by the camera could decrease the accuracy of these detectors or could even prevent detection at all. This is because such overlay fields are always stable, have a high contrast and sharpness and can therefore balance real picture changes, so that the overall change is too small to be detected. The solution is to disable the text overlay at the camera's own web page.

"Focus lost" and "focus gained" events:

A dynamic scene with moving objects of various sizes always changes the average sharpness a little bit and the detector tries to filter out these small variations. This is not always possible, so one can sometimes experience false "focus lost" or a "focus gained" events.

Covering the camera should cause a "camera covered" event, but the effects of the covering could be very similar (from the algorithm's point of view) to a moved camera or to a lost focus. So the algorithm has to decide what happened and the result is not always the proper event category (one may get "camera moved" and more usually "focus lost" instead of "camera covered"). However, a sabotage event should occur at unusual situations, it is just possible that the detailed category will not match the actual reason.

Hint: As the three sabotage types have many properties in common, to get the best detection rate switch on all sabotage categories. For example, a camera cover event might be categorized as a focus lost, because then image sharpness drops dramatically. If this category is also switched on, the sabotage will surely be detected.

iCAT event settings

You can also specify event-related properties on an iCAT definition:

1. You can also choose a specific **Icon** and **Sound** for the event when it is shown in the event task bar.

2. You can also define a special event priority for events generated by the trigger by setting the value **Priority of generated event**. Please note that the event priority is a relative priority whereby 100 is the default priority (see also *8 Handling events* on page 63).
3. The check boxes **Save event in event list** and **Do not save event in event list** allow you to selectively override the general setting for the camera schedule which is defined in *14.3.9 Scheduling iCAT operation and recording* on page 115).

14.3.5 Defining simple motion detection

Prior to release R1.12 VisoGuard offered simple motion detection based on a detection of changed pixels between video frames. Since then this detector has been made more robust and it is now part of iCAT toolbox. Simple motion detection does not require an object tracking region. For more details on setting up and working with this simple motion detection please refer to *7 Working with simple motion detection* on page 58.

14.3.6 Detecting a lighting change

Please follow these steps to enable lighting change detection:

Please note: For lighting change detection an object tracking region is NOT needed.

1. Choose **Video analysis (iCAT)** from the **System administration** menu. This opens the **Video analysis (iCAT)** dialog.
2. Choose a camera and in the menu select **Add new definition**.
3. In the **Type** pop-up menu choose **Lighting change detection**, which will expose the configuration settings.
4. Select the checkboxes for **Light switched on** and **Light switched off** to detect abrupt lighting changes like when somebody switches the light on or off.

You can also enter values in the **Brightness high limit (%)** and **Brightness low limit (%)** fields to detect slower lighting changes like during sunrise and sundown. If you leave these values empty, then slower lighting change detection will be disabled.

5. In the **Identifier** text field enter a name for this definition.
6. Push **Save** to save your definition.

Please note:

- If you add a new iCAT definition, it will automatically be assigned to all iCAT schedules of the camera. If you do not want that, you have to remove the assignment manually (see *14.3.9 Scheduling iCAT operation and recording* on page 115).
- If a definition is not assigned to a schedule then it will not be activated and no archive recordings will be made and no events will be generated.

iCAT event settings

You can also specify event-related properties on an iCAT definition:

1. You can also choose a specific **Icon** and **Sound** for the event when it is shown in the event task bar.
2. You can also define a special event priority for events generated by the trigger by setting the value **Priority of generated event**. Please note that the event priority is a relative priority whereby 100 is the default priority (see also *8 Handling events* on page 63).
3. The check boxes **Save event in event list** and **Do not save event in event list** allow you to selectively override the general setting for the camera schedule which is defined in *14.3.9 Scheduling iCAT operation and recording* on page 115).

14.3.7 Defining a privacy mask

Privacy masks allow hiding private areas of a camera view from live viewing and recording.

This is an example of a privacy mask hiding the text on the carpet:



Here are the steps for creating a privacy mask:

Please note:

- For privacy masking an object tracking region is NOT needed.
- Currently, privacy masks are not shown in exported streams and in the Layout Navigation tool.

1. Choose **Video analysis (iCAT)** from the **System administration** menu. This opens the **Video analysis (iCAT)** dialog.
2. Choose a camera and in the menu select **Add new definition**.
3. In the **Type** pop-up menu choose **Privacy mask**, which will expose the configuration settings.
4. Under the camera preview choose the **Rectangle** or **Polygon** check box.
5. Now you can draw the privacy field with the mouse in the preview pane. For a polygon you just click with the mouse to define the corners of the polygon. You close the polygon by crossing an existing edge or by double clicking with the mouse.
6. In the **Identifier** text field enter a name for this privacy mask.
7. Push **Save** to save your definition.

Please note:

- If you add a new iCAT definition, it will automatically be assigned to all iCAT schedules of the camera. If you do not want that, you have to remove the assignment manually (see [14.3.9 Scheduling iCAT operation and recording](#) on page 115).
- If a definition is not assigned to a schedule then it will not be activated and no archive recordings will be made and no events will be generated.

iCAT event settings

You can also specify event-related properties on an iCAT definition:

1. You can also choose a specific **Icon** and **Sound** for the event when it is shown in the event task bar.
2. You can also define a special event priority for events generated by the trigger by setting the value **Priority of generated event**. Please note that the event priority is a relative priority whereby 100 is the default priority (see also [8 Handling events](#) on page 63).

- The check boxes **Save event in event list** and **Do not save event in event list** allow you to selectively override the general setting for the camera schedule which is defined in *14.3.9 Scheduling iCAT operation and recording* on page 115).

14.3.8 Defining removed/abandoned object detection

iCAT offers to detect removed and abandoned objects in a defined region.

Please note: For removed/abandoned object detection an object tracking region is NOT needed. Be careful with the size of the region since a greater size will cause a more CPU overhead on the server.

Here are the steps:

- Choose **Video analysis (iCAT)** from the **System administration** menu. This opens the **Video analysis (iCAT)** dialog.
- Select a camera and in the menu choose **Add new definition**.
- In the **Type** pop-up menu choose **Removed/abandoned object**, which will expose the configuration settings.
- Under the camera preview choose the **Rectangle** or **Polygon** check box.
Now you can draw the field with the mouse in the preview pane in which you want to detect removed or abandoned objects
For a polygon you just click with the mouse to define the corners of the polygon. You close the polygon by crossing an existing edge or by double clicking with the mouse. Here is an example of such a field.



Please note: The size of the region for removed/abandoned objects should be at least 50% larger than the objects you want to detect. Never draw the region too tight around the object of interest because the underlying algorithm analyses also the object's direct surroundings. A region too close to the object can make detection impossible.

- Select whether you want to **Detect removed objects**, **Detect abandoned objects** or both.
- In the field **Min. stay time for removed/abandoned objects (sec)** you can enter a minimum time a recognized object must stay, before a remove or abandoned detection on the object and a corresponding event is triggered. Sometimes, in difficult cases, these time limits are exceeded by the detector with a few seconds but usually detection time is close to the values defined. See *Further considerations and limitations* below.
- In the field **Minimum size removed/abandoned objects (area in pix)** you can constrain the object size for the event trigger.
Currently those measures are definable in pixels (please keep in mind that the resolution iCAT works on is either CIF or QVGA depending on the aspect ratio of the camera). Zero values in these fields mean that there is no constraint.

Hint for constraining the object size: The size is the area of the object in pixels and the speed is also measured in pixels per second. To know what object sizes or speeds you want to filter it is helpful to watch a few objects passing the triggers and switch on the object markers. These markers show the size and speed of the object in pixels. These are exactly the same measures that you can use for the trigger. Here is an example of an object marker (Object ID is [10], object size is 9110 pixels, speed is 208 pixels/sec):

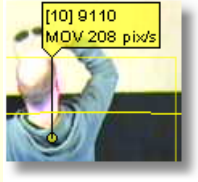

The section *14.4.1 Displaying iCAT information in the Online monitor and when playing recordings* on page 117 shows you how to view object markers.

8. In the **Identifier** text field enter a name for this event trigger.
9. Push **Save** to save your definition.

Please note:

- If you add a new iCAT definition, it will automatically be assigned to all iCAT schedules of the camera. If you do not want that, you have to remove the assignment manually (see *14.3.9 Scheduling iCAT operation and recording* on page 115).
- If a definition is not assigned to a schedule then it will not be activated and no archive recordings will be made and no events will be generated.

iCAT event settings

You can also specify event-related properties on an iCAT definition:

1. You can also choose a specific **Icon** and **Sound** for the event when it is shown in the event task bar.
2. You can also define a special event priority for events generated by the trigger by setting the value **Priority of generated event**. Please note that the event priority is a relative priority whereby 100 is the default priority (see also *8 Handling events* on page 63).
3. The check boxes **Save event in event list** and **Do not save event in event list** allow you to selectively override the general setting for the camera schedule which is defined in *14.3.9 Scheduling iCAT operation and recording* on page 115).

Further considerations and limitations

- Abrupt brightness changes and large variation of white balance (as automatically set by several cameras) may cause false detection, especially false detection of removed objects. In general, if these two conditions become worse, the algorithm become less reliable. The best conditions are provided by a stably lit indoor situation. However, the algorithm can also work successfully in outdoor situations. If the lighting conditions are varying heavily, it is recommended to use just abandoned detection (removed detection is switched off), because it is more robust to such varying lighting conditions (through longer detection timeout).
- The region must be carefully defined, i.e. the interesting objects (for example objects of a theft detection) must be fully located inside the region. For example: If you want to detect when your telephone is removed from the table, you can define a relatively small region around the phone to avoid false detections elsewhere, but the region must be a bit larger than the phone allowing the robust detection of its contours. The situation is the same in case of abandoned objects. Abandoned objects which are partially located outside the region may not be detected.
- The objects which are apparently static (stopped person who moved before, person sitting in an office) can also cause false alarms. The detector tries to track moving objects and keep their

position when they stop, in order to ignore such objects during detection of really static ones. However through the failures of the tracking such objects may be lost and wrongly classified as an abandoned one. A stopped person who is lost by the tracker becomes the subject of removed/abandoned classification after the given alarm timeout. If it starts moving before the timeout reached, there will be no false alarm raised.

The possibility of the above mentioned problem increases with the number of person in the scene (as tracker reliability decreases) or with people who only show movement rarely (person working in an office). In the former case you can increase the abandoned detection timeout in order to be more robust, but in the latter one masking out the area where the apparently static person is should be the best.

- There are two alarm timeouts to be set. One for abandoned and one for removed objects. If the scenery is clear, the interesting object is visible then the alarm event will be raised by and large if the timeout is reached. But when another moving or stopped objects (for example the actor itself who is going to leave a luggage) hides or overlaps the interesting object such that it is visible only partially or not at all, the detection time may be longer. So these timeouts are not guaranteed detection timeouts but rather parameters which can increase robustness (setting them longer) or to increase sensitivity (setting them shorter). Of course the alarm event will follow the detection some time around the timeout but the difference depends strongly on the observed scenery.

14.3.9 Scheduling iCAT operation and recording

This section describes how to schedule iCAT video analysis operation and how to define the related event-based recording.

Here are the steps:

1. Choose **Camera admin** from the **System administration** menu. This opens the **Camera admin** dialog.
2. In the camera tree select the camera that you want to schedule. Go to the **Scheduling** dialog by clicking on **Next** at the bottom.
3. In the menu select **Modify selected camera or group**.
4. Press the **Add** button below the **Time intervals** list and choose **Video analysis (iCAT)** from the type button labeled **Change**.
5. Now define the days and times when iCAT should be enabled for this camera. You can activate individual days or, with the **All** button, the whole week at once. Select hours and minutes from the time popup.
Please make sure that the **Enable interval** checkbox is marked, because only then the settings are enabled.

Note: You can create multiple iCAT intervals for different setups at different times. For each interval proceed as described here.

6. Check the assigned iCAT definitions to this interval via the **Assigned iCAT definitions** popup menu at the right side of the dialog. Per default all available iCAT definitions for this camera are assigned. If you do not want that you can remove them now by deselecting the definition that you do not want in this interval.
7. You can also define whether something should be recorded at an event triggered by one of the assigned iCAT definitions. For that you have a full set of options to set which are described in *6.1.1 Programming continuous timed recordings* on page 45.

In addition to the parameters for continuous timed recordings you can specify a **Pre-event frame rate (fps)** which can differ from that after the event defined by **Frame rate (fps)**. With **Pre/Post-event recording (sec)** you can specify how long before and after the event you want to record.

Please note: If there is an active continuous recording in MPEG format, it does not make sense to have any **Pre/post-event recording (sec)** set for the event-based recording. This is because MPEG recording is only done in one quality. See also below for further considerations on pre- and post-event recording.

8. iCAT events for this camera are only stored in the Event database and only appear in the **Event list** if the flag **Save event in Event list** is switched on. Otherwise only the recording will start but no event will be generated.
You can override this setting for individual iCAT events selectively in the corresponding iCAT definition (e.g. *14.3.2 Defining an event trigger for people and object counting (Smart Tripwire™)* on page 105).
9. For all other recording settings please refer to *6.1.1 Programming continuous timed recordings* on page 45.
10. Push **Save**.

Please note: iCAT-triggered event generation and recording is only active if there is an enabled iCAT interval and there is at least one enabled iCAT definition assigned. Outside of this time interval there is no recording or event generation. Furthermore, recording is started only if either of the fields for **Pre/post-event recording (sec)** is bigger than zero.

Further considerations for pre- and post-event recording

VisoGuard allows you to define the frame rate and quality of event-based recordings. If you want to save video streams for events generated by the video analytics toolkit iCAT please keep in mind that VisoGuard needs to analyze the video stream that it later stores.

Some cameras have limitations when providing multiple video streams at different qualities and frame rates. Therefore VisoGuard tries to retrieve only 1 video stream with 1 quality and frame rate setting whenever possible. This also helps to keep the CPU load for the server and the camera at a minimum.

Here is some information about how event-based recording depending on the video format and pre/post-event frame rate setting is done. This can help you to tune your system to better fit your needs while reducing burden on the server and the camera. For further information on which video format is best for iCAT please refer also to *14.2.1 Considerations for setting up a system with iCAT* on page 101.

Please note: If the recording event is not generated by iCAT, then the recording behavior is the same as described here, just iCAT is not analyzing the video stream. Simple motion detection involves iCAT. If both, iCAT-based and other event-triggered recording is active at the same time, iCAT recording parameters have priority for obtaining pre-alarm streams.

Event-based recording for iCAT in MJPEG format

- Different frame rates for pre and post event recording

VisoGuard obtains a QVGA stream for iCAT analyzing and also uses this stream for pre-event recording. In case of an iCAT-based event or alarm, VisoGuard switches to the frame rate and quality defined by the main recording settings (post event).

Please note: Depending on the camera there can be a small delay caused by the camera needed to switch from the pre-event streaming format to the post-event streaming format.

- The same frame rate for pre and post-event recording

VisoGuard obtains 1 stream of the main (post-event) recording quality. It also does iCAT analyzing based on this stream (it actually scales the image sizes down to QVGA). In case of an event/alarm, the video stream format is not changed.

Advantage: same images for pre/post event recordings. No delay between pre- and post-event recording.

Disadvantage: CPU load is bigger since images need to be scaled down for iCAT analyzing.

Event-based recording for iCAT in MPEG formats (MPEG-4, H.264, and MxPEG)

The majority of MPEG cameras cannot deliver multiple MPEG streams with different formats. Only 1 stream is delivered from the camera. Therefore you need to set the default frame rate to at least the detection frame rate you need for iCAT (see Default settings in *3.2 Adding a new camera and setting basic properties* on page 21).

- There is no pre-event recording (recording time is 0)

VisoGuard obtains a QVGA MJPEG stream from the camera and runs iCAT analyzing on it. In the case of an event, the streaming format is switched to MPEG and recording is started.

Advantage: minimal overhead on server CPU.

Disadvantage: Depending on the camera there can be a small delay caused by the camera needed to switch from the pre-event streaming format MJPEG to the post-event MPEG format.

- There is pre-event recording (recording time is bigger than 0)

VisoGuard obtains the MPEG stream from the cameras and also does iCAT based on it. Recording is also done with this stream. Please note that iCAT based on MPEG stream needs more CPU power on the server (see also *14.2.1 Considerations for setting up a system with iCAT* on page 101).

Continuous and event-based recording at the same time

If the continuous recording has the same frame rate quality like the post-event recording, then only continuous recording is done and the recording calendar is marked with the events.

If continuous recording is done at a lower frame rate or different quality, then the stream will be restarted with the post-event frame rate and quality in the case of an event.

iCAT processing will be done with continuous recording frames (scaled down in size and/or frame rate if necessary). Pre-alarm setting has no relevance in this case.

14.4 Working with iCAT

In this section you will learn about:

- Watching iCAT information live in the **Online monitor** and also when replaying recordings.
- Displaying Visual Statistics™ in the **Online monitor**.
- Generating reports on iCAT events like people counting and stopped objects.

14.4.1 Displaying iCAT information in the Online monitor and when playing recordings

For each camera that has active iCAT schedules enabled you can display additional iCAT information like object markers and bounding boxes and event trigger fields in the **Online monitor** and also when playing back recordings.

Here is an example of additional iCAT information displayed:



To choose what iCAT information to display you have these options:

In the **Online monitor** in the view port of a camera that has iCAT processing enabled the view port control menu offers an **iCAT info display** menu (for setting the display for all view ports in a view the same menu is also available via the View control menu **Set parameters of all view ports**).

Also in the **Archive player** you also have an iCAT button with the same menu.

The **iCAT info display** menu allows you to select from various display options: For each of these options you can select **Show always**, **Show on mouse over**, and **Do not show**. For some you also can select **Show on event**.

The display options are:

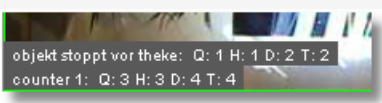
Tracking boundaries	defines whether the object tracking region boundaries should be shown.
Event trigger lines/boxes	defines whether the event triggers like tripwires and object starting/stopping fields should be shown.
Object markers	<p>defines whether object markers should be displayed. Object markers show the object ID and information about the state of the object (MOV = moving, STP = stopped, LOUNGE = move just a little bit), size and speed.</p>  <p>In this example object ID is [10], object size is 9110 pixels, and the object is moving with a speed of 208 pixels/sec.</p>
Event count fields	<p>defines whether the event count fields are to be displayed in the lower left corner of the view port. When enabled the count information will be displayed for each event trigger separately in the form of Q for last quarter of an hour, H for last hour, D for day and T for total since setup. Here is an example:</p>  <p>There are two event triggers: a field for counting stopped objects and a people counting tripwire (counter 1).</p>
Object	defines whether object bounding boxes should be displayed.

bounding boxes

Here is an example of an object bounding box displayed:



Please note that also the object marker and the event triggers are displayed.

14.4.2 Displaying Visual Statistics™

For each camera that has active iCAT schedules enabled you can display Visual Statistics™ as overlays to the normal video stream in the **Online monitor** and also when playing back recordings.

Please be aware that the statistics are available only inside the object tracking region and that the tracking region must have the collection of statistics enabled (see *14.3.1 Defining an object tracking region* on page 103).

This is an example of visual object count statistics:

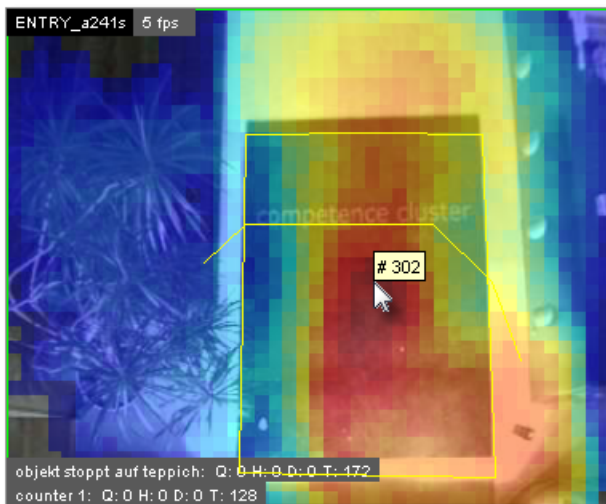

To choose what Visual statistics to display you have these options:

In the **Online monitor** in the view port of a camera that has iCAT processing enabled the view port control menu offers a **Visual statistics** menu (for setting the display for all view ports in a view the same menu is also available via the View control menu **Set parameters of all view ports**).

Also in the **Archive player** you also have an iCAT button with the same menu.

The **iCAT video statistics** menu allows you to select the following statistics to display:

For the display of those Visual Statistics you can choose between **Show always**, **Show on mouse over**, and **Do not show**.

In the screen dump above you see an example of the overall object count statistics in an entrance situation. Cold colors mean few object counts and hot colors mean high object counts. When you

move the mouse over the camera view you can see the actual object count for each segment of the view. Above the count in the middle of the screen would be 302 objects.

As a comparison, here you see the Visual Statistics of the stopped object counts of the same camera:

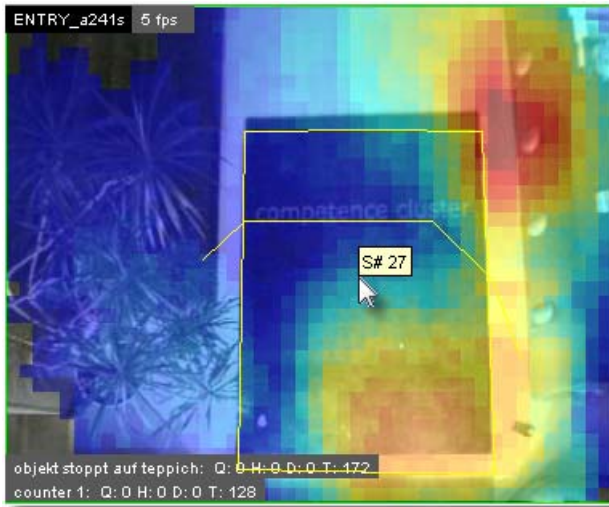

Notice the difference in coloring. You see that people only very seldom stop in the middle of the carpet but stop very often in front of the welcome counter.

Resetting the Visual Statistics

To reset the statistics to zero follow these steps:

1. Choose **Video analysis (iCAT)** from the **System administration** menu. This opens the **Video analysis (iCAT)** dialog.
2. Choose the camera and then the object tracking region.
3. In the menu select **Modify selected definition**.
4. Push the **Next** button to go to the statistics pane.
5. Disable the checkboxes of those statistics you want to reset.
6. Push the **Save** button to save the changes. Now the statistics counts of the disabled statistics are reset.
7. Now enable the statistics again by repeating the above steps accordingly. Do not forget to push **Save** again.

14.4.3 Working with iCAT events

Working with iCAT events is the same as working with other events of the VisoGuard event management system EMS (as described in *8 Handling events* on page 63).

Currently, iCAT generates events of the following types (as shown in the event type hierarchy dialog of the Event search; see *8.1 Event list and event details* on page 63):

- Camera specific messages
 - State change events
 - Video analysis (iCAT) events
 - Simple motion detection**
 - iCAT object tracking**

All events that are generated by iCAT (that are not simple motion detection) like people counting, object stopping, and sabotage detection are of type **iCAT Object tracking**. Therefore if you want to filter iCAT events you have to choose the event type **iCAT Object tracking**.

You can differentiate events for the various iCAT event triggers by their names. You can also create event statistics reports in Excel XLS format (see *8.3 Generating an event statistics report* on page 67).

15 Special functions

This chapter describes some special functions of VisoGuard.

15.1 Video annotations

Video streams for live viewing and recording can be annotated with text that then displayed in the video stream. The annotations can come from external data sources and can be stored in the event database for later retrieval and search.

Annotations can be created via the SNAP XML interface or with a simple shell command with command line options.

Example applications are POS cash register data, ATM data, logistics data, or access control data.

15.1.1 Working with video annotations

You can access the video annotation tools from the server's web page:

1. At the server's web page click on **Customizer login** to login to the Customizer area (the admin password is needed for that).
2. After login click on **Download configuration files**.
3. Download the file **annotate.zip** and unpack the zip to a local directory on your client.
4. The zip contains the Windows command line program **annotate.exe**. Just run the program from a command line to see all options. You can also refer to `annotate-readme.txt`. (The Java source code of the program is also part of the zip file)
5. If you select to generate an event with the video annotation, an event will be stored in the event database for later retrieval and search. By selecting `VideoStreamAnnotation` in the event type filter of the **Event search** dialog, the annotation text can be searched for by SQL-type wildcards.

15.2 Embedding VisoGuard video streams in web pages (Snapplet)

VisoGuard allows you to embed live video streams in standard web pages. Currently only MJPEG stream are supported. The embedding HTML code can be generated by VisoGuard.

15.2.1 Generating the embedding HTML code and testing it

You can generate the embedding HTML code from the server's web page:

1. At the server's web page click on **Customizer login** to login to the Customizer area (the admin password is needed for that).
2. After login click on **Generate embedding HTML code**.
3. Now you can set several options for the embedded applet like size and streaming properties.
4. A click on **Generate applet tag** will open another window that contains the generated HTML code.
5. Push the **Demo** button to run and test the applet in your browser.
1. for later retrieval and search. By selecting `VideoStreamAnnotation` in the event type filter of the **Event search** dialog, the annotation text can be searched for by SQL-type wildcards.

15.3 Controlling VisoGuard with HTTP commands from external sources (URL control)

URL control is one way to enable third-party applications to start actions via URL-encoded strings (send http GET request to an VisoGuard server). The server upon receiving these special URL requests executes the actions as if they would have been generated internally.

For testing purposes, you can execute URL control by entering an HTTP command in a standard web browser.

```
http://<your-server>/arms/servlet/BrowserServlet?cmd=clientcontrol&...
```

Here is a list of available URL control parameters:

- **selector.tool=** name of the target tool in the client application (possible values: **online_monitor**, **archive_tool**)
- **selector.machine=** optional IP address of the target client PC
- **selector.user=** optional name of the logged-in target user (if both machine and user are specified then only the client application is selected which fulfills both conditions)

Further action parameters are:

- **action.action=** the action to be executed (possible values: **show_live_stream**, **show_calendar**, **play_archive**, **draw_bounding_box**)
- **action.cameraid=** ID of camera that is involved in the action
- **action.mode=** further descriptor for the action (possible values: **pop_if_exists**, **show_as_large**, **show_in_view**, **show_all_cams**)
- **action.fromtime=** from time stamp (YYYY-MM-DDTHH:MM:SS or millisecs since Unix epoch) of archive playback. Should be given only when action is **play_archive**.
- **action.totime=** to time stamp of playback (YYYY-MM-DDTHH:MM:SS or millisecs since Unix epoch). Should be given only when action is **play_archive**.
- **action.idlist=** comma separated list of camera ids which we want the archive playback or want to place them in the current Online monitor view . Should be given only when action is **show_live_stream** or **play_archive**.
- **action.panelname=** name of Online monitor view that should be exposed. Should be given only when mode is **show_in_view** or **show_all_cams**. Following conditions exist:
 - If **panelname** does not exist it will be created and all cameras listed in the **idlist** parameter will be placed into it.
 - If **panelname** exists with the cameras listed on the **idlist** parameter, it will be popped up.
 - If **panelname** exists but the **idlist** parameter contains more cameras as there already are in the view, then: 1) if we have enough view-ports to show the rest of the cameras it will be shown there, or 2) if the view can not handle any more view-ports, a new view will be created where all listed cameras are then placed.
- **box.x0=** upper left x coordinate of box (valid between 0 and 1000). The values are in 1/10th percentages of the displayed image. Box parameters should be supplied only when the action is **draw_bounding_box**.
- **box.y0=** upper left y coordinate of box (valid between 0 and 1000)
- **box.x1=** lower right x coordinate of box (valid between 0 and 1000)
- **box.y1=** lower right y coordinate of box (valid between 0 and 1000)
- **box.linewidth=** line width used when drawing the box
- **box.color=** color of the box (possible values: black, blue, cyan, darkgray, gray, green, lightgray, magenta, orange, pink, red, white, yellow)
- **box.text=** text which is written into the box
- **box.timeout=** seconds after the box disappears automatically (0 mean click to disappear)

Please note: URL control is only enabled for allowed computers whose IP addresses are known to the server (see *10.2 Setting VisoGuard server parameters* on page 78 for details). All other requests are blocked.

Please refer to the *Release Notes* for further details or updates on URL control.

15.3.1 URL control examples

Create an action that brings up images of camera ID 12 in a large view on a client machine where the "admin" user is logged in (we assume that the address of the server to which we are sending the URL control is 192.168.7.2):

```
http://192.168.7.2/arms/servlet/BrowserServlet?cmd=clientcontrol&selector.user=admin
&selector.tool=online_monitor&action.action=show_live_stream
&action.mode=show_as_large&action.cameraid=12
```

Create action which draws a red box (for two seconds) onto the frame of camera ID 12 in the Online Monitor of the "admin" user:

```
http://192.168.7.2/arms/servlet/BrowserServlet?cmd=clientcontrol&selector.user=admin
&selector.user=admin&selector.tool=online_monitor
&action.action=draw_bounding_box&box.x0=100&box.y0=100&box.x1=500&box.y1=500
&box.linewidth=2&box.color=red&box.text=MD&box.timeout=3&action.cameraid=12
```

Each server offers a simple test page for URL control at the following address:

http://<your-server>/URLtest.jsp.

15.4 Matrix view function of the Online monitor (VIP control)

With the matrix view function (also called VIP control) you can control, which cameras defined in a bigger matrix are displayed in a view in the Online monitor.

For example, assume you have a big area covered with 50 cameras. Each of these 50 cameras cover a part of the overall area. The Matrix view function now allows you to position all the cameras in a huge virtual matrix covering the whole area:

Cam1	Cam2	Cam3	Cam4	Cam5	Cam6	Cam7	Cam8	Cam9	Cam10
Cam11	Cam12	Cam13	Cam14	Cam15	Cam16	Cam17	Cam18	Cam19	Cam20
Cam21	Cam22	Cam23	Cam24	Cam25	Cam26	Cam27	Cam28	Cam29	Cam30
Cam31	Cam32	Cam33	Cam34	Cam35	Cam36	Cam37	Cam38	Cam39	Cam40
Cam41	Cam42	Cam43	Cam44	Cam45	Cam46	Cam47	Cam48	Cam49	Cam50

Now assume that in the VisoGuard Online monitor you want to show adjacent cameras of this virtual matrix in a 3x3 view. Whenever you double click any of the 50 cameras in any of the views in VisoGuard this camera is then positioned as the center of the 3x3 view and the adjacent cameras of the big matrix are automatically positioned around it. In the example above you see how the 3x3 view would look like if you would double click Cam24 and Cam18.

The Matrix view function is defined by XML files sitting on the server. The name of the XML files follows the form **server.utils.CameraMatrixMapping.<action>.xml**. You start by downloading and

editing the file **server.utils.CameraMatrixMapping.sample.xml**. When you are done with editing you upload the file under a specific name to the server.

15.4.1 Download the XML config file

You can access the XML file in a web browser from the server's web page:

1. At the server's web page click on **Customizer login** to login to the Customizer area (the admin password is needed for that).
2. In the Customizer click on **Download configuration files**.
3. In the list of files find and save **server.utils.CameraMatrixMapping.sample.xml** to your local hard disk. You can do that by right clicking on the file and then choosing **Save link as...** from the menu.

15.4.2 Edit the XML config file

Edit the file according to your needs. A detailed description about the function can be found in the comment at the beginning of the file. When you are done with editing save the file under a file name that reflects the trigger action for which you want to enable the Matrix view.

Possible trigger actions for the Matrix function and the corresponding XML file names are:

Trigger action	XML file name
double click in a camera view port	server.utils.CameraMatrixMapping.DOUBLE-CLICK.xml
single click in a camera view port	server.utils.CameraMatrixMapping.SINGLE-CLICK.xml
LNT: single click, double click, mouse over or context menu on a camera icon	server.utils.CameraMatrixMapping.LNT.xml

In addition to the above you can also control on which VisoGuard clients the Matrix view function should be triggered. You can do that by downloading and editing the file **server.utils.TargetActionMapping.sample.xml**.

15.4.3 Upload and activate the XML config files

You can upload and activate the Matrix function by following these steps:

1. At the server's web page click on **Customizer login** to login to the Customizer area (the admin password is needed for that).
2. In the Customizer under the heading **Upload configuration files** click on the button **Choose file**.
3. In the opened file dialog choose the file that you want to upload and push **Open**. Repeat this step for all files you want to upload.
4. Uploading a properly filled CameraMatrixMapping file to the server will activate the mapping function. No server restart is necessary, changes become active within 10 seconds after upload.

15.5 Holiday calendar

A holiday calendar allows you to define a list of special days (holidays) and to modify the standard recording schedules of cameras for these days (enable or disable recordings).

The holiday calendar is defined in an XML file that can be accessed via the standard server web page.

15.5.1 Download the XML config file

You can access the XML file in a web browser from the server's web page:

1. At the server's web page click on **Customizer login** to login to the Customizer area (the admin password is needed for that).
2. In the Customizer click on **Download configuration files**.
3. In the list of files find and save **HolidayCalendar.SAMPLE.xml** to your local hard disk. You can do that by right clicking on the file and then choosing **Save link as...** from the menu.

15.5.2 Edit the XML config file

Edit the file according to your needs. A detailed description about the function can be found in the comment at the beginning of the file. When you are done with editing, save the file.

The SAMPLE file has to be renamed to **HolidayCalendar.xml**.

Please note: The holiday calendar has to be configured on camera servers (NCS). Controlling recording over user servers (NUS) is not supported.

15.5.3 Upload and activate the XML config file

You can upload and activate the function by following these steps:

1. At the server's web page click on **Customizer login** to login to the Customizer area (the admin password is needed for that).
2. In the Customizer under the heading **Upload configuration files** click on the button **Choose file**.
3. In the opened file dialog choose the file **HolidayCalendar.xml** and upload it to the server.
4. Please restart VisoGuard to activate settings of the holiday calendar.

15.6 Automatic export of event statistics data

VisoGuard allows you to automatically export event statistics data in the format of a CSV (comma-separated text file) that can be easily read by programs like MS Excel. The details of the statistics like resolution, duration and filters for event types and camera can be flexibly defined.

The exported file will be stored in the file system of the server. This means you must have file system access to the server in order to obtain the file. You can do that, for example, via FTP and the admin user and password . Or you can mount a network drive (via Samba or NFS) and place the file there.

The statistics export function is defined by an XML file sitting on the server. You must download, edit, and then upload the file in order to configure and activate the function.

15.6.1 Download the XML config file

You can access the XML file in a web browser from the server's web page:

1. At the server's web page click on **Customizer login** to login to the Customizer area (the admin password is needed for that).
2. In the Customizer click on **Download configuration files**.
3. In the list of files find and save **StatisticExportConfig.ACTIVE.xml** to your local hard disk. You can do that by right clicking on the file and then choosing **Save link as...** from the menu.
Please note: If there is no such file then download the **StatisticExportConfig.sample.xml**.

15.6.2 Edit the XML config file

Edit the file according to your needs. A detailed description about the function can be found in the comment at the beginning of the file. When you are done with editing save the file.

If you want to access the generated statistics files via FTP, we suggest that you create the output file in /home/admin. If you want to put the file on a mounted network drive then use the mount location.

The SAMPLE file has to be renamed to **StatisticExportConfig.ACTIVE.xml**.

15.6.3 Upload and activate the XML config file

You can upload and activate the function by following these steps:

1. At the server's web page click on **Customizer login** to login to the Customizer area (the admin password is needed for that).
2. In the Customizer under the heading **Upload configuration files** click on the button **Choose file**.
3. In the opened file dialog choose the file **StatisticExportConfig.ACTIVE.xml** and upload it to the server.
4. Please restart VisoGuard to activate settings of the automatic event export.

15.7 Configuring I/O devices

VisoGuard allows you to work with I/O contacts of cameras and special I/O devices.

The I/O device configuration is done by XML files sitting on the server. You must download, edit, and then upload the files in order to configure and activate the function.

15.7.1 Download the XML config files

You can access the XML file in a web browser from the server's web page:

1. At the server's web page click on **Customizer login** to login to the Customizer area (the admin password is needed for that).
2. In the Customizer click on **Download configuration files**.
3. In the list of files you find several XML files that are responsible for the device configuration:

XML file name	Trigger action
server.externalIO.deviceio.DeviceMappings.xml	Actual I/O device configuration
server.externalIO.deviceio.DeviceTypeDescriptor.<device_type>.xml	Device descriptor files (not intended for modification by you)

Save **server.externalIO.deviceio.DeviceMappings.xml** and the to your local hard disk. You can do that by right clicking on the file and then choosing **Save link as...** from the menu.

Please note: If there is no such file then download the **server.externalIO.deviceio.DeviceMappings.sample.xml**.

15.7.2 Edit the XML config files

Edit the file **server.externalIO.deviceio.DeviceMappings.xml** to your needs. A detailed description about the function can be found in the comment at the beginning of the file.

For each supported I/O device types there is a device descriptor file

server.externalIO.deviceio.DeviceTypeDescriptor.

<device_type>.xml. For configuring a device you must refer to one of the supported devices in **server.externalIO.deviceio.DeviceMappings.xml**.

When you are done with editing, save the file.

Please note: The sample file has to be renamed to **server.externalIO.deviceio.DeviceMappings.xml**.

15.7.3 Upload and activate the XML config files

You can upload and activate the function by following these steps:

1. At the server's web page click on **Customizer login** to login to the Customizer area (the admin password is needed for that).
2. In the Customizer under the heading **Upload configuration files** click on the button **Choose file**.
3. In the opened file dialog choose the file **server.externalIO.deviceio.DeviceMappings.xml** and upload it to the server.
4. Please restart VisoGuard to activate settings of the automatic event export.

16 Index

4

4CIF 8

A

ABS transcoding for low-bandwidth connections 19

 configuring ABS 80

Acknowledging events 64

Active Directory 33

AES encryption of video recordings 81

Annotating videos with data from external sources 122

Anonymize voice 23

Apple iPhone 87

Archive See Recording

Aspect ratio

 of JPEG images 8, 22

 of Online monitor views 35

 PAL, NTSC, VGA, HDTV 35

Audio

 playback in archive 52

 settings 23

 working with cams 42

AVI

 exporting from archive 54

B

Bandwidth

 limiting overall outgoing bandwidth of server 80

 support for low bandwidth via Transcoding 19

Brightness 27

C

Calendar in archive 48

Camera

 access rights for users 32

 default settings 23

 duplicate existing camera with similar settings 27

 groups 28

 moving in camera tree 29

 multicast streaming for MPEG 23

 port mapping on video server 29

 privacy mask 112

 sabotage detection 109

 setup 21

 status display (LNT) 98

 video analytics (iCAT) 100

Camera finder in the Online monitor 38

Camera server (NCS) 82

Camera tree

 drag and drop cameras 36

 how to work with it 36

 positioning in the window 19

CIF 8

Client

 installation directory for client components 16

 introduction 10

 languages 12

 locally installed 14

 multi-window/multi-screen operation 17

 overview of components 18

 preferences 18

 starting 15

- support for low-bandwidth connections 19
- web browser 11
- Clone camera 27
- Contrast 27
- CPU load
 - and streaming formats 7
 - display of server CPU load 75
 - for video analytics (iCAT) 102
- Cropped view ports
 - define which part to display 39

D

- Data integration with external applications 122
- Data security 5
- Default settings
 - for cameras 23
- Deleting windows 19
- Demo mode license 10
- DivX exporting from recordings 54
- Documentation set 5
- Drag and drop
 - camera from the camera tree to view ports 36
- Duplicate existing camera 27

E

- Encryption
 - AES encryption of video recordings 81
 - general description 5
 - HTTPS for camera connections 22
 - HTTPS for client connections 11, 15
 - HTTPS for server-server connections 84
- Event list
 - create a separate Event list window 19
 - maximizing 19
 - positioning in the window 19

- Event triggers (iCAT) 101, 105
- Events 63
 - acknowledging 64
 - automatic export of statistics data 126
 - details 64
 - Event list 63
 - modifying layouts 19
 - priorities 63
 - sorting 63
 - event-based recording 115
 - exporting event-related recordings 66
 - HTML export 66
 - in layout navigation 98
 - priorities 63
 - remote servers 86
 - searching in the event database 65
 - short replay 64
 - statistics 67
 - statistics data automatic export 126
 - user privileges for accessing and handling 63
 - video analysis (iCAT) 120
- Exiting the client 20
- Export of event statistics data 126
- Exporting archive recordings 54
 - event-related 66
- External applications
 - control via HTTP commands 123

F

- Floating window components 19
- Four-eyes principle 30
- Frame rate
 - changing in view port 38
 - maximizing 38

G

Google Chrome

optimizing settings for browser client Web Start (JNLP files) 14

H

H.264 6, See also MPEG

HDTV 16/9

aspect ratio in Online monitor 35

Holiday calendar 125

HTML code for embedding streams in web pages 122

HTTP commands for starting actions 123

HTTPS encryption

between servers 84

for camera connection 22

for client connection 11, 15

general description 5

I

I/O contacts

configuring I/O devices 127

placing them on LNT layouts 91

settings 26

I/O devices

configuring 127

iCAT 100

considerations for setting up 101

CPU load 102

event triggers 101, 105

event-based recording 115

events 120

object bounding boxes 118

object counting 105

object markers 118

object tracking region 101, 103

people counting 105

privacy mask 112

recording based on 115

removed/abandoned objects 113

sabotage detection 109

scheduling activities 115

sensitivity setting 104

Smart Tripwire(tm) 105

starting and stopping objects 108

video processing speed 103

video streaming formats 102

Visual Statistics™ 119

working with in Online monitor 117

In-camera motion detection 61

settings 26

IP address

of camera 22

iPhone 87

J

Joystick control for PTZ cameras 73

JPEG

aspect ratio 8, 22

exporting from archive 54

image sizes and quality 8

MJPEG vs. MPEG 6

L

Languages 12

Layout navigation 88

editing mode 89

I/O contacts 91

installation 88

navigation and operation 97

zones 91

Layout of windows

modifying 19

LDAP 33

License

displaying current license 76

license string 10

Login

secondary password 30

the locally installed client 15

the web-based client 13

Low-bandwidth connections with Transcoding
19

M

Manual recording control in the Online monitor
40

Matrix view function (VIP control) 124

MJPEG 7

versus MPEG streaming 7

Mobile devices, PDAs 87

Motion detection 58

in archive 56

in-camera 61

recording based on 115

server-based 58

Motion JPEG 7

MPEG 6, 7

settings 23

versus MJPEG streaming 7

working with cams 42

MPEG-4 6, See also MPEG

Multi streaming (parallel video streams) 6

enabling 23

optimizing iCAT operation 102

Multicast streaming for MPEG cameras 23

Multi-screen operation 17

positioning windows 19

Multi-window operation 17

MxPEG 6, See also MPEG

N

NCS camera server 82

NETAVIS_DIRECTORY environment variable
for installed client components 16

NNS synchronization groups of servers 82

NTSC 8

NUS user server 82

O

Object bounding boxes (iCAT) 118

Object counting (iCAT) 105

Object markers (iCAT) 118

Object tracking region 101

Online monitor 35

creating views 35

defining views for new user 32

dynamic control with iCAT and motion
detection 43

dynamic control with the Matrix function (VIP
control) 124

manual recording control 40

navigating in the 37

quick camera finder 38

view port quality settings 38

view settings 38

working with iCAT 117

zooming in a view port 39, 51

Overlay painting 17

P

PAL 8

pan, tilt, zoom 69

Password

changing 33

PDAs (mobile devices) 87

People counting (iCAT) 105
 Playback of archive recordings 48
 Port mapping
 of analog cameras on video server 29
 Preferences of the client 18
 Priority
 of events 63
 sorting event list 63
 Privacy mask (iCAT) 112
 Privileges of users 31
 Protect archive recordings against deletion 53
 PTZ (pan/tilt/zoom) 69
 automatic routes 73
 control with motion detection 60
 controlling camera 70
 joystick control 73
 routes 69
 user priority 31

Q

QCIF 8
 Quality settings
 changing in view port 38
 Quitting the client 20

R

Recording 45
 AES encryption of video recordings 81
 Audio playback 52
 calendar 48
 continuous (timed) 45
 DivX export 54
 event-based recording 115
 exporting 54
 exporting event-related recordings 66
 holiday calendar 125

iCAT-based recording 115
 manual recording control in the Online monitor 40
 motion detection in 56
 Playback 48
 programming 45
 protection against deletion 53
 SAFE format export 55
 save space with frame rate reduction for older parts of the archive 47
 storage management 47
 synchronous playback of mutiple cameras 52
 time zooming 52
 Release notes 5
 Remote servers 82
 events 86
 monitoring 86
 Restarting and rebooting 78
 Round tours 41
 RTSP streaming port 80

S

Sabotage detection (iCAT) 109
 SAFE format archive export 55
 Saturation 27
 Scheduling
 iCAT activities 115
 Screen resolution
 minimum for running the client 11
 Secondary password
 for login 30
 Security 5
 Sensitivity setting (iCAT) 104
 Server
 administrating 75
 information about running servers 75

- interconnected 82
- load display 75
- network 82
 - camera server (NCS) 82
 - synchronization groups 82
 - user server (NUS) 82
- setting parameters 78
- Smart guard function 41
- Smart Tripwire (iCAT) 105
- Smartphones (mobile devices) 87
- Snapplet, embedding live video streams in web pages 122
- Statistics
 - events 67
 - iCAT Visual Statistics™ 119
- Storage management in archive 47
- Streaming formats 6
 - changing in view port 38
 - iCAT video analytics 102
- Synchronization groups of servers 82
- Synchronous playback of mutiple cameras in archive 52

T

- Time zone of server 78
- Time zooming in archive 52
- Transcoding for low-bandwidth connections 19
 - setting up 80
- Tripwire for object counting (iCAT) 105

U

- URL control
 - allowed IP addresses 80
 - control from external applications 123
- User server (NUS) 82
- Users

- Active Directory/LDAP 33
 - adding 30
 - camera access rights 32
 - copying view between 42
 - groups 32
 - info about logged in 32
 - managing 30
 - privileges 31

V

- VGA 8
- Video analytics 100, See iCAT
- video annotations 122
- Video compression 6
 - MPEG vs. MJPEG 6
 - Transcoding for low bandwidth connections 19
- View port
 - define crop view 39
- View ports
 - creating 35
 - quality settings 38
 - zooming camera views 39, 51
- Views
 - copying between users 42
 - Online monitor 35
 - round tours 41
 - settings 38
- VIP control (matrix view function) 124
- Visual Statistics™ (iCAT) 119

W

- Web pages
 - embedding live video streams 122
- Windows
 - create a separate Event list window 19

deleting 19

modifying layouts 19

in an Online monitor view port 39, 51

in SAFE exports 55

of PTZ cameras 72

Z

Zones in layout navigation (LNT) 91

Zooming